

Welch Allyn<sup>®</sup>  
XScribe<sup>™</sup> 5  
STRESS EXERCISE TESTING SYSTEM  
**SERVICE MANUAL**

Manufactured by Welch Allyn, Inc., Skaneateles Falls, NY U.S.A.

---



**CAUTION:** *Federal law restricts this device to sale by or on the order of a physician.*

©2019 Welch Allyn This document contains confidential information that belongs to Welch Allyn, Inc. No part of this document may be transmitted, reproduced, used, or disclosed outside of the receiving organization without the express written consent of Welch Allyn, Inc. Welch Allyn is a registered trademark of Welch Allyn, Inc. AM12, RSCRIBE, WAM, XSCRIBE, and X12+ are trademarks of Welch Allyn, Inc. SCF (Source Consistency Filter) is a copyright of Welch Allyn, Inc. Microsoft and Windows are registered trademarks of Microsoft Corporation. Adobe and Acrobat are registered trademarks of Adobe Systems Incorporated. DICOM is the registered trademark of the National Electrical Manufacturers Association for its standards publications relating to digital communications of medical information. Software V5.

For patent information, please visit [www.welchallyn.com/patents](http://www.welchallyn.com/patents)

For information about any Welch Allyn product, visit: <https://www.welchallyn.com/en/about-us/locations.html>

Customer Service and Technical Support: <https://www.welchallyn.com/en/other/contact-us.html> 1.888.667.8272,  
[mor\\_tech.support@hillrom.com](mailto:mor_tech.support@hillrom.com)

**REF** 9516-185-50-ENG Rev C (also refer to the TDR pages when making revision changes)  
Revision Date: 2021-01

**#** 901144 CARDIAC STRESS TESTING SYSTEM



Welch Allyn, Inc.  
4341 State Street Road  
Skaneateles Falls, NY 13153 USA

[www.welchallyn.com](http://www.welchallyn.com)

**EC** **REP** EU IMPORTER

Welch Allyn Limited  
Navan Business Park, Dublin Road,  
Navan, Co. Meath C15 AW22  
Ireland

# TABLE OF CONTENTS

<b>NOTICES</b> .....	<b>3</b>
MANUFACTURER’S RESPONSIBILITY .....	3
RESPONSIBILITY OF THE CUSTOMER .....	3
EQUIPMENT IDENTIFICATION .....	3
COPYRIGHT AND TRADEMARK NOTICES .....	3
OTHER IMPORTANT INFORMATION .....	3
NOTICE TO EU USERS AND/OR PATIENTS.....	3
DISPOSAL .....	3
<b>WARRANTY</b> .....	<b>4</b>
YOUR WELCH ALLYN WARRANTY .....	4
<b>USER SAFETY INFORMATION</b> .....	<b>5</b>
WARNING(S) .....	5
CAUTION(S) .....	6
NOTE(S).....	7
<b>EQUIPMENT SYMBOLS AND MARKINGS</b> .....	<b>8</b>
SYMBOL DELINEATION .....	8
<b>ELECTROMAGNETIC COMPATIBILITY (EMC)</b> .....	<b>9</b>
TABLE X-1 GUIDANCE AND MANUFACTURER’S DECLARATION: ELECTROMAGNETIC EMISSIONS .....	10
TABLE X-2 GUIDANCE AND MANUFACTURER’S DECLARATION: ELECTROMAGNETIC IMMUNITY.....	10
TABLE X-3 GUIDANCE AND MANUFACTURER’S DECLARATION: ELECTROMAGNETIC IMMUNITY.....	11
TABLE X-4 RECOMMENDED SEPARATION DISTANCES BETWEEN PORTABLE AND MOBILE RF COMMUNICATIONS EQUIPMENT AND THE EQUIPMENT .....	12
<b>INTRODUCTION</b> .....	<b>13</b>
MANUAL PURPOSE.....	13
PERIODIC SAFETY INSPECTIONS .....	13
PROPER POWER CORD .....	13
PROPER FUSE .....	13
DO NOT OPERATE IN EXPLOSIVE ATMOSPHERES .....	13
USE ONLY SAFE METHODS OF INTERCONNECTION .....	13
DO NOT MOUNT PRODUCT ABOVE PATIENT .....	13
RECOMMENDED ACCESSORIES .....	13
SYSTEM DESCRIPTION .....	14
MISCELLANEOUS SYSTEM INFORMATION .....	14
XSCRIBE SYSTEM* .....	15
XSCRIBE FRONT END TYPES .....	16
XSCRIBE ICON DESCRIPTIONS .....	17
XSCRIBE TECHNICAL SPECIFICATIONS .....	18
XSCRIBE HARDWARE SPECIFICATIONS .....	19
M12RFXXX-USB BLOCK DIAGRAM .....	21
M12C-USB AND M12RF-USB INPUT CONNECTIONS .....	22
M12C-USB AND M12RF-USB OUTPUT CONNECTIONS .....	22
MEDICAL ISOLATION TRANSFORMER .....	23
TREADMILL .....	24
HISTORICAL REFERENCE TABLES: .....	25
<b>MAINTENANCE &amp; CLEANING</b> .....	<b>27</b>

MAINTENANCE PROCEDURE .....	27
TREADMILL PREVENTIVE MAINTENANCE .....	27
XSCRIBE SYSTEM PREVENTIVE MAINTENANCE AND CLEANING .....	28
SYSTEM CHECKS.....	29
CONFORMANCE TESTING.....	30
SAFETY TESTING.....	30
XSCRIBE PREVENTIVE MAINTENANCE REPORT .....	31
<b>DEVICE CONFIGURATION.....</b>	<b>32</b>
ADMINISTRATIVE TASKS .....	32
MANAGE USER ACCOUNTS .....	32
MANAGE/CREATE GROUPS.....	33
MODALITY SETTINGS .....	33
FILE EXCHANGE .....	37
DICOM SETTINGS .....	37
UNLOCK EXAMS.....	37
MANAGE ARCHIVE STORAGE.....	37
AUDIT TRAIL LOGS .....	38
SERVICE LOGS .....	38
CONFIGURE WORKFLOW .....	38
USER PREFERENCES.....	39
REPORT CONFIGURATION TOOL .....	40
RF SCAN FOR X12+ .....	41
<b>UNIT DISASSEMBLY .....</b>	<b>42</b>
FRONT BEZEL REMOVAL .....	45
FRONT BEZEL SECURITY.....	46
POWER SUPPLY REPLACEMENT .....	47
XSCRIBE ITEM DESCRIPTION LISTING .....	48
<b>TROUBLESHOOTING .....</b>	<b>49</b>
TROUBLESHOOTING CHART .....	49
<b>CONFORMANCE TESTING .....</b>	<b>53</b>
ACQUISITION MODULE PREPARATION .....	53
SYSTEM CHECKS.....	53
FUNCTIONAL TESTING .....	54
SAFETY TESTING.....	54
XSCRIBE 5 SYSTEM - TEST DATA RECORD .....	55
<b>COMMUNICATION OPTIONS .....</b>	<b>56</b>
FILE EXCHANGE .....	56
<b>SYSTEM UTILITIES.....</b>	<b>59</b>
FETCHALLCONFIG.EXE .....	59
ACTIVATIONTOOL.EXE.....	60
CFDWIZARD.EXE.....	61
<b>SYSTEM BACKUP AND RESTORATION .....</b>	<b>62</b>
SYSTEM BACKUP .....	62
SYSTEM RESTORATION .....	64

# NOTICES

---

## Manufacturer's Responsibility

Welch Allyn, Inc. is responsible for the effects on safety and performance only if:

- Assembly operations, extensions, readjustments, modifications, or repairs are carried out only by persons authorized by Welch Allyn, Inc.
- The device is used in accordance with the instructions for use.

## Responsibility of the Customer

The user of this device is responsible for ensuring the implementation of a satisfactory maintenance schedule. Failure to do so may cause undue failure and possible health hazards.

## Equipment Identification

Welch Allyn, Inc. equipment is identified by a serial and reference number on the back of the device. Care should be taken so that these numbers are not defaced. Software equipment is accompanied by an identification card; carefully store this card as the information is needed for activation, upgrade and customer service.

## Copyright and Trademark Notices

This document contains information that is protected by copyright. All rights are reserved. No part of this document may be photocopied, reproduced, or translated to another language without prior written consent of Welch Allyn, Inc.

## Other Important Information

The information in this document is subject to change without notice.

Welch Allyn, Inc. makes no warranty of any kind with regard to this material including, but not limited to, implied warranties of merchantability and fitness for a particular purpose. Welch Allyn, Inc. assumes no responsibility for any errors or omissions that may appear in this document. Welch Allyn, Inc. makes no commitment to update or to keep current the information contained in this document.

## Notice to EU Users and/or Patients

Any serious incident that has occurred in relation to the device, should be reported to the manufacturer and the competent authority of the Member State in which the user and/or patient is established.

## Disposal

This product and its accessories must be disposed of according to local laws and regulations. Do not dispose of this product as unsorted municipal waste. For more specific disposal information see [www.welchallyn.com/weee](http://www.welchallyn.com/weee).

# WARRANTY

---

## Your Welch Allyn Warranty

WELCH ALLYN, INC. (hereinafter referred to as "Welch Allyn") hereby warrants that Welch Allyn products (hereinafter referred to as "Product/s") shall be free from defects in material and workmanship under normal use, service, and maintenance for the warranty period of such Product/s from Welch Allyn or an authorized distributor or representative of Welch Allyn. The warranty period is defined as twenty-four (24) months following the date of shipment from Welch Allyn. Normal use, service, and maintenance means operation and maintenance in accordance with appropriate instructions and/or information guides. This warranty does not apply to damage to the Product/s caused by any or all of the following circumstances or conditions:

Freight damage;

Parts and/or accessories of the Product/s not obtained from or approved by Welch Allyn;

Misapplication, misuse, abuse, and/or failure to follow the Product/s instruction sheets and/or information guides;

Accident; a disaster affecting the Product/s;

Alterations and/or modifications to the Product/s not authorized by Welch Allyn;

Other events outside of Welch Allyn's reasonable control or not arising under normal operating conditions.

THE REMEDY UNDER THIS WARRANTY IS LIMITED TO THE REPAIR OR REPLACEMENT WITHOUT CHARGE FOR LABOR OR MATERIALS, OR ANY PRODUCT/S FOUND UPON EXAMINATION BY WELCH ALLYN TO HAVE BEEN DEFECTIVE. This remedy shall be conditioned upon receipt of notice by Welch Allyn of any alleged defects promptly after discovery thereof within the warranty period. Welch Allyn's obligations under the foregoing warranty will further be conditioned upon the assumption by the purchaser of the Product/s (i) of all carrier charges with respect to any Product/s returned to Welch Allyn's principal place or any other place as specifically designated by Welch Allyn or an authorized distributor or representative of Welch Allyn, and (ii) all risk of loss in transit. It is expressly agreed that the liability of Welch Allyn is limited and that Welch Allyn does not function as an insurer. A purchaser of a Product/s, by its acceptance and purchase thereof, acknowledges and agrees that Welch Allyn is not liable for loss, harm, or damage due directly or indirectly to an occurrence or consequence there from relating to the Product/s. If Welch Allyn should be found liable to anyone under any theory (except the expressed warranty set forth herein) for loss, harm, or damage, the liability of Welch Allyn shall be limited to the lesser of the actual loss, harm, or damage, or the original purchase price of the Product/s when sold.

EXCLUDED FROM THE LIMITED WARRANTY SET FORTH ABOVE ARE CONSUMABLE ITEMS SUCH AS PAPER, BLOOD PRESSURE CUFFS, BLOOD PRESSURE HOSES, BATTERIES, ELECTRODES, PATIENT CABLES, LEAD WIRES, AND MAGNETIC STORAGE MEDIUMS.

EXCEPT AS SET FORTH HEREIN WITH RESPECT TO REIMBURSEMENT OF LABOR CHARGES, A PURCHASER'S SOLE EXCLUSIVE REMEDY AGAINST WELCH ALLYN FOR CLAIMS RELATING TO THE PRODUCT/S FOR ANY AND ALL LOSSES AND DAMAGES RESULTING FROM ANY CAUSE SHALL BE THE REPAIR OR REPLACEMENT OF DEFECTIVE PRODUCT/S TO THE EXTENT THAT THE DEFECT IS NOTICED AND WELCH ALLYN IS NOTIFIED WITHIN THE WARRANTY PERIOD. IN NO EVENT, INCLUDING THE CLAIM FOR NEGLIGENCE, SHALL WELCH ALLYN BE LIABLE FOR INCIDENTAL, SPECIAL, OR CONSEQUENTIAL DAMAGES, OR FOR ANY OTHER LOSS, DAMAGE, OR EXPENSE OF ANY KIND, INCLUDING LOSS OF PROFITS, WHETHER UNDER TORT, NEGLIGENCE OR STRICT LIABILITY THEORIES OF LAW, OR OTHERWISE. THIS WARRANTY IS EXPRESSLY IN LIEU OF ANY OTHER WARRANTIES, EXPRESS OR IMPLIED, INCLUDING, BUT NOT LIMITED TO THE IMPLIED WARRANTY OF MERCHANTABILITY AND THE WARRANTY OF FITNESS FOR A PARTICULAR PURPOSE.

## USER SAFETY INFORMATION

---



**WARNING:** Means there is the possibility of personal injury to you or others.



**Caution:** Means there is the possibility of damage to the device.

**Note:** Provides information to further assist in the use of the device.



### **WARNING(S)**

- This manual gives important information about the use and safety of this device. Deviating from operating procedures, misuse or misapplication of the device, or ignoring specifications and recommendations could result in increased risk of harm to users, patients and bystanders, or damage to the device.
- Device captures and presents data reflecting a patient's physiological condition that when reviewed by a trained physician or clinician can be useful in determining a diagnosis; however, the data should not be used as a sole means for determining a patient's diagnosis.
- Users are expected to be licensed clinical professionals knowledgeable about medical procedures and patient care, and adequately trained in the use of this device. Before attempting to use this device for clinical applications, the operator must read and understand the contents of the user manual and other accompanying documents. Inadequate knowledge or training could result in increased risk of harm to users, patients and bystanders, or damage to the device. Contact Welch Allyn service for additional training options.
- To maintain designed operator and patient safety, peripheral equipment and accessories used that can come in direct patient contact must be in compliance with UL 60601-1, IEC 60601-1, and IEC 60601-2-25. Only use parts and accessories supplied with the device and available through Welch Allyn, Inc.
- Patient cables intended for use with the device include series resistance (9Kohm minimum) in each lead for defibrillation protection. Patient cables should be checked for cracks or breakage prior to use.
- Conductive parts of the patient cable, electrodes, and associated connections of type CF applied parts, including the neutral conductor of the patient cable and electrodes, should not come into contact with other conductive parts including earth ground.
- The device is part of an integral personal computer-based diagnostic system. The user must adhere to all warnings in order to ensure safe and reliable performance.
- If operated on AC (~) power, the personal computer must be connected with its original power cable to an electrical installation that complies with applicable regulations for environments where patients are treated.
- The personal computer used and any peripheral devices connected to it must be approved to the appropriate safety standard for nonmedical information technology equipment per IEC 60950, or its national variants.
- The personal computer and any peripheral devices connected to it, being non-medical electrical equipment, must be situated outside the patient environment per IEC 60601-1. To ensure the safety of the patient it must not be possible for the operator to touch the patient and the computer at the same time. In general, at least 1.5 meters (5') of open area must surround the patient to achieve this.

- If the personal computer is situated within the patient environment, ensure that its level of safety is that of medical electrical equipment per IEC 60601-1. This may be accomplished by powering the computer and any other equipment connected to it through an isolation transformer or by operating on battery power.
- If the personal computer is situated within the patient environment, to maintain designed operator and patient safety when a LAN network connection is being used, the network cable must be connected to the device through an Ethernet isolator module that complies with IEC 60601-1 (available from Welch Allyn).
- ECG electrodes could cause skin irritation; patients should be examined for signs of irritation or inflammation.
- To avoid the possibility of serious injury or death during patient defibrillation, do not come into contact with device or patient cables. Additionally, proper placement of defibrillator paddles in relation to the electrodes is required to minimize harm to the patient.
- This device was designed to use the electrodes specified in this manual. Proper clinical procedure must be employed to prep the electrode sites and to monitor the patient for excessive skin irritation, inflammation, or other adverse reactions. Electrodes are intended for short-term use and should be removed from the patient promptly following testing. Do not mix electrodes made of dissimilar metals.
- To avoid potential for spread of disease or infection, single-use disposable components (e.g., electrodes) must not be reused. To maintain safety and effectiveness, electrodes must not be used beyond their expiration date.
- A possible explosion hazard exists. Do not use the device in the presence of flammable anesthetic mixture.
- Possible malfunction risks may be present when installing third-party software. Welch Allyn, Inc. cannot verify the compatibility of all possible hardware/software combinations.
- The device has not been designed for use with high-frequency (HF) surgical equipment and does not provide a protective means against hazards to the patient.
- The quality of the signal produced by the device may be adversely affected by the use of other medical equipment, including but not limited to defibrillation and ultrasound machines.
- When the software is installed on the XScribe™ Stress Exercise system, refer to the XScribe user manual for additional warnings.



### **Caution(s)**

- Do not attempt to clean the patient cables by submersing into a liquid, autoclaving, or steam cleaning as this may damage equipment or reduce its usable life. Wipe the exterior surfaces with a warm water and mild detergent solution and then dry with a clean cloth. Use of unspecified cleaning/disinfecting agents, failure to follow recommended procedures, or contact with unspecified materials could result in increased risk of harm to users, patients and bystanders, or damage to the device.
- Do not pull or stretch patient cables as this could result in mechanical and/or electrical failures. Patient cables should be stored after forming them into a loose loop.



















## Note(s)

- Patient movements may generate excessive noise that may affect the quality of the ECG traces and the proper analysis performed by the device.
- Proper patient preparation is important to proper application of ECG electrodes and operation of the device.
- There is no known safety hazard if other equipment, such as pacemakers or other stimulators, is used simultaneously with the device; however, disturbance to the signal may occur.
- If an electrode is not properly connected to the patient, or one or more of the patient cable lead wires is damaged, the display will indicate a lead fault for the lead(s) where the condition is present.
- As defined by IEC 60601-1 and IEC 60601-2-25, the device is classified as follows:
  - Type CF, defibrillation-proof applied parts.If not specifically indicated otherwise, personal computer equipment used with the device can be regarded as:
  - Class I (if the computer has a three-prong power inlet) or class II (if it has a two-prong inlet)
  - Ordinary equipment.
  - Equipment not suitable for use in the presence of a flammable anesthetic mixture.
  - Continuous operation.
- To prevent possible damage to the device during transport and storage (while in original packaging) the following environmental conditions must be adhered to:
  - Ambient temperature: -20° C to 65° C (-4° F to 149° F)
  - Relative humidity: 10% to 95%, non-condensing
  - Atmospheric pressure: 500 hPa to 1060 hPa
- Allow the device and any computer equipment used to stabilize within its intended operating environment for a minimum of two hours prior to use. Refer to the computer equipment user manual for allowable environmental conditions. The allowable environmental conditions for the AM12 and WAM acquisition modules are as follows:
  - Ambient temperature: 10° C to 40° C (50° F to 104° F)
  - Relative humidity: 10% to 95%, non-condensing
  - Atmospheric pressure: 500 hPa to 1060 hPa

# EQUIPMENT SYMBOLS AND MARKINGS

---

## Symbol Delineation

	CAUTION The caution statements in this manual identify conditions or practices that could result in damage to the equipment or other property, or loss of data.
	WARNING The warning statements in this manual identify conditions or practices that could lead to illness, injury, or death. In addition, when used on a patient applied part, this symbol indicates defibrillation protection ins in the cables. Warning symbols will appear with a grey background in a black and white document.
	Alternating current
	Protective earth
	Fuse
	Defibrillator-proof type CF applied part
	Input
	Green light illuminates when power is ON
	Green light illuminates when paper is out or an error condition is detected
	Advances paper to the next paper perforation and will reset a paper error condition. When depressed for approximately 7 seconds; will reset device.
	Do not dispose as unsorted municipal waste. Requires separate handling for waste disposal according to local requirements.
	Indicates compliance to applicable European Union directives
	Follow instructions/directions for use (DFU) – mandatory action. A copy of the DFU is available on this website. A printed copy of the DFU can be ordered from Welch Allyn for delivery within 7 calendar days.
	Medical Device
	Model Identifier
	Reorder Number

*NOTE: Refer to the manual(s) accompanying the device that pertain to the computer hardware for additional definitions of symbols that may be present.*

## **ELECTROMAGNETIC COMPATIBILITY (EMC)**

---

Electromagnetic compatibility with surrounding devices should be assessed when using the device.

An electronic device can either generate or receive electromagnetic interference. Testing for electromagnetic compatibility (EMC) has been performed on the device according to the international standard for EMC for medical devices (IEC 60601-1-2). This IEC standard has been adopted in Europe as the European Norm (EN 60601-1-2).

The device should not be used adjacent to, or stacked on top of other equipment. If the device must be used adjacent to or stacked on top of other equipment, verify that the device operates in an acceptable manner in the configuration in which it will be used.

Fixed, portable, and mobile radio frequency communications equipment can affect the performance of medical equipment. See Table X-4 for recommended separation distances between the radio equipment and the device.

The use of accessories, transducers, and cables other than those specified by Welch Allyn may result in increased emissions or decreased immunity of the equipment.

**Table X-1 Guidance and Manufacturer's Declaration: Electromagnetic Emissions**

The equipment is intended for use in the electromagnetic environment specified in the table below. The customer or the user of the equipment should ensure that it is used in such an environment.

Emissions Test	Compliance	Electromagnetic Environment: Guidance
RF Emissions CISPR 11	Group 1	The equipment uses RF energy only for its internal function. Therefore, its RF emissions are very low and not likely to cause any interference in nearby electronic equipment.
RF Emissions CISPR 11	Class A	
Harmonic Emissions IEC 61000-3-2	Complies	
Voltage Fluctuations/ Flicker Emissions IEC 61000-3-3	Complies	

**Table X-2 Guidance and Manufacturer's Declaration: Electromagnetic Immunity**

The equipment is intended for use in the electromagnetic environment specified in the table below. The customer or the user of the equipment should ensure that it is used in such an environment.

Emissions Test	Compliance	Compliance Level	Electromagnetic Environment: Guidance
Electrostatic discharge (ESD) IEC 61000-4-2	+/- 6 kV contact +/- 8 kV air	+/- 6 kV contact +/- 8 kV air	Floors should be wood, concrete, or ceramic tile. If floors are covered with synthetic material, the relative humidity should be at least 30%.
Electrical fast transient/burst IEC 61000-4-4	+/- 2 kV for power supply lines +/- 1 kV for input/output lines	+/- 2 kV for power supply lines +/- 1 kV for input/output lines	Mains power quality should be that of a typical commercial or hospital environment.
Surge IEC 61000-4-5	+/- 1 kV differential mode +/- 2 kV common mode	+/- 1 kV differential mode +/- 2 kV common mode	Mains power quality should be that of a typical commercial or hospital environment.
Voltage dips, short interruptions, and voltage variations on power supply input lines IEC 61000-4-11	<5% UT (>95% dip in UT) for 0.5 cycle 40% UT (60% dip in UT) for 5 cycles	<5% UT (>95% dip in UT) for 0.5 cycle 40% UT (60% dip in UT) for 5 cycles	Mains power quality should be that of a typical commercial or hospital environment.
Power frequency (50/60 Hz) magnetic field	3 A/m	3 A/m	Power frequency magnetic fields should be at levels characteristic of a typical location in a typical commercial or hospital environment.

**NOTE:** UT is the AC Mains voltage prior to application of the test level.

**Table X-3 Guidance and Manufacturer's Declaration: Electromagnetic Immunity**

The equipment is intended for use in the electromagnetic environment specified in the table below. The customer or the user of the equipment should ensure that it is used in such an environment.

Emissions Test	IEC 60601 Test Level	Compliance Level	Electromagnetic Environment: Guidance
Conducted RF IEC 61000-4-6	3 Vrms 150 kHz to 80 MHz	3 Vrms 150 kHz to 80 MHz	<p>Portable and mobile RF communications equipment should be used no closer to any part of the equipment, including cables, than the recommended separation distance calculated from the equation applicable to the frequency of the transmitter.</p> <p><b>Recommended separation distance</b></p> $d = \frac{3.5}{\sqrt{3V_{rms} f}} \sqrt{P}$
Radiated RF IEC 61000-4-3	3 V/m 80 MHz to 2.5 GHz	3 V/m 80 MHz to 2.5 GHz	$d = \frac{3.5}{\sqrt{3V/m f}} \sqrt{P} \quad 80 \text{ MHz to } 800 \text{ MHz}$ $d = \frac{7}{\sqrt{3V/m f}} \sqrt{P} \quad 800 \text{ MHz to } 2.5 \text{ GHz}$ <p>Where <math>P</math> is the maximum output power rating of the transmitter in watts (W) according to the transmitter manufacturer and <math>d</math> is the recommended separation distance in meters (m).</p> <p>Field strengths from fixed RF transmitters, as determined by an electromagnetic site survey<sup>a</sup>, should be less than the compliance level in each frequency range<sup>b</sup>.</p> <p>Interference may occur in the vicinity of equipment marked with the following symbol:</p> 

- a. Field strengths from fixed transmitters, such as base stations for radio (cellular/cordless) telephones and land mobile radios, amateur radios, AM and FM radio broadcast, and TV broadcast cannot be predicted theoretically with accuracy. To assess the electromagnetic environment due to fixed RF transmitters, an electromagnetic site survey should be considered. If the measured field strength in the location in which the equipment is used exceeds the applicable RF compliance level above, the equipment should be observed to verify normal operation. If abnormal performance is observed, additional measures may be necessary, such as reorienting or relocating the equipment.
- b. Over the frequency range 150 kHz to 80 MHz, field strengths should be less than [3] V/m.

### Table X-4 Recommended Separation Distances Between Portable and Mobile RF Communications Equipment and the Equipment

The equipment is intended for use in the electromagnetic environment in which radiated RF disturbances are controlled. The customer or the user of the equipment can help to prevent electromagnetic interference by maintaining a minimum distance between portable and mobile RF communications equipment (transmitters) and the equipment as recommended in the table below, according to the maximum output power of the communications equipment.

Rated Maximum Output Power of Transmitter W	Separation Distance According to Frequency of Transmitter (m)	
	150 KHz to 800 MHz	800 MHz to 2.5 GHz
	$d = 1.2\sqrt{P}$	$d = 2.3\sqrt{P}$
0.01	0.1 m	0.2 m
0.1	0.4 m	0.7 m
1	1.2 m	2.3 m
10	4.0 m	7.0 m
100	12.0 m	23.0 m

For transmitters rated at a maximum output power not listed above, the recommended separation distance  $d$  in meters (m) can be estimated using the equation applicable to the frequency of the transmitter, where  $P$  is the maximum output power rating of the transmitter in watts (W) according to the transmitter manufacturer.

**NOTE 1:** At 800 MHz, the separation distance for the higher frequency range applies.

**NOTE 2:** These guidelines may not apply in all situations. Electromagnetic propagation is affected by the absorption and reflection from structures, objects, and people.

# INTRODUCTION

---

## Manual Purpose

The purpose of this manual is to supply information to service personnel so they can maintain the XScribe 5 System, information for peripheral devices should be found in manuals supplied with equipment or by contacting original manufacturer. This manual is intended to function primarily as a guide to preventative and corrective maintenance and electrical repairs considered field repairable.

**NOTE:** *This manual may contain screen shots. Screen shots are provided for reference only and are not intended to convey actual operating techniques. Consult the actual screen in the host language for specific wording.*

## Periodic Safety Inspections

Follow the recommended maintenance schedule. Inspect the power cord and transmission cables periodically for fraying or other damage and replace as needed. Broken or frayed wires may cause interference or loss of signal.

Pay particular attention to points where wires enter connectors.

## Proper Power Cord

The power cords from all the peripheral equipment should be plugged into the Isolation Transformer. This product requires a three-wire, (18 gauge, SJT-grade) power cord, which is supplied with a three-terminal, polarized plug (hospital grade) for connection to the power source and protective ground. Use of the Isolation Transformer supplied, is required. An interruption of the grounding connection could cause an electrical shock hazard.

## Proper Fuse

Applies to Isolation Transformer only. Use only the fuse specified for the equipment (identical in type, voltage, and current rating). Substituting a different fuse type could cause a fire hazard. Always make sure fuses have been installed before operating the equipment.

## Do Not Operate in Explosive Atmospheres

Do not operate the X-Scribe 5 in the presence of flammable gasses or anesthetics, this environment could cause an explosion. Refer to Operator's Manual Safety Information: Warning(s) and Caution(s).

## Use Only Safe Methods of Interconnection

To prevent electrical shock from the product when it is connected to other electrical equipment, proper grounding is essential. Refer to Operator's Manual Safety Information: Warning(s) Peripheral equipment.

## Do Not Mount Product above Patient

Do not mount or place any part of the product where it could fall on a patient or where it could be accidentally knocked off a shelf or other mounting arrangement.

## Recommended Accessories

For the patient's safety and optimum equipment performance, use only the accessories specified by Welch Allyn, Inc.

## System Description

The XScribe is a high-performance, PC-based, dedicated color, stress exercise testing system with an exam database capable of acquiring, viewing, printing, and storing ECG, NIBP, and SpO<sub>2</sub> data. The XScribe may be used with a treadmill, ergometer, or pharmacological form of testing. The device is equipped with Welch Allyn's VERITAS™ resting ECG interpretation algorithm. This feature enables the VERITAS algorithm to provide an over-reading physician with a silent second opinion through diagnostic statements output on the supine and Mason-Likar ECG reports. The interpretive portion of the ECG is available in the pre-exercise portion of the test. For additional information on the VERITAS algorithm, please refer to the *Physician's Guide to VERITAS 7 Resting ECG Interpretation*. (See Parts and Accessories.)

The XScribe system can function as a standalone workstation or can be set up in a distributed configuration where the database resides on a server supporting a number of networked client workstations.

The XScribe Review software offers users with appropriate permissions at a networked location the ability to schedule new exams when not linked to an external scheduling system, view full disclosure exams, enter conclusions, and generate printed or electronic reports for completed exams.

The XScribe workstation includes:

- PC with keyboard and mouse
- X12+ transmitter
- M12A or AM12 for traditional wired connection
- 24" wide screen color monitor
- Isolation transformer
- ECG lead wires
- Carry case with belt
- Software
- System cart

Optional items include:

- High-speed laser printer
- Z200+ thermal array printer
- Treadmill
- Ergometer
- Multi-modality module for wireless RF transmitter with TTL and analog output
- Multi-modality module for wired M12A with TTL and analog output
- Programmable remote keypad
- Local area network (LAN)
- Integrated non-invasive blood pressure monitoring with or without SpO<sub>2</sub>

## Miscellaneous System Information

- XScribe is capable of supporting the following video resolutions: 1920 x 1080, and 1920 x 1200.
- XScribe is capable of supporting HP LaserJet printers with 600 dpi and PCL5 capabilities, and Welch Allyn's Z200+ thermal printer.
- A supplied network isolation device must be installed between the PC and wall network plug. This is to ensure compliance with IEC 60601-1-1 standard.

**NOTE:** No user-serviceable parts are inside. ANY modification to device may alter defibrillator protection. Any modification to any part of device is to be performed by qualified service personnel only.



## XScribe System\*

Figure 1-1



**XScribe with Z200+ Thermal Writer and  
Additional Storage Bin**

## XScribe Front End Types

There are three front end types for patient connection that can be used with XScribe, two of which require the use of the Multi-Modality Module.

### Multi-modality Module (MMM)

MMM supports both X12+ wireless and M12A wired front ends with TTL/Analog output, required for TANGO+ BP Monitor interface and ECG signal output for echocardiographs and other devices. Antennas are connected with 18" cables and must be at least 12" apart when installed for the X12+.



### X12+ Digital Transmitter

12-lead telemetry transmitter with Welch Allyn's patented LeadForm patient cable operates in 608 MHz or 2500 MHz frequency. Uses one AA alkaline battery for approximately 24-hours of continuous operation. Includes impedance check and ECG display to ensure good quality patient hookup. The RF Scan tool can be used with this front end for optimal channel selection. Refer to the X12+ User Manual and short form instruction card for detailed information.



### M12A Patient Cable

12-lead patient cable together with Welch Allyn's patented LeadForm patient cable for connection to MMM when a wired connection and TTL/analog output is desired.











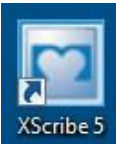

### AM12 Patient Cable

AM12 for a traditional wired connection allows direct USB connection with 40,000 Hz ECG acquisition. LED for lead fail notification. Uses replaceable lead wires with medi-clip connectors. Refer to the AM12 short form instruction card for detailed information.



## XScribe Icon Descriptions

Icon and Hover Text	Description
	XScribe desktop shortcut icon to launch the Stress modality application.
 Schedule/Orders	Opens a window allowing exam scheduling and schedule review.  <i>This icon is only available when XScribe is not linked to an external scheduling system.</i>
 Start a Stress Test	Opens a window presenting scheduled exams or the Search Patient list when no exams are scheduled allowing association of patient demographic data with the exam. The stress hookup display is opened when the Start Exam button is selected.
 Worklist	Opens a window displaying exams with a preset filter showing only Acquired, Edited, or Reviewed status according to user preference. Checkboxes in the window allow further filtering.
 Exam Search	Opens a window allowing users to search for Stress exams in the database using filters.
 Patient Search	Opens a window allowing users to search for patients in the database using filters and editing of the patient demographics.
 User Preferences	Opens a window for configuring the user preferences for the Worklist and changing the password.
 System Configuration	Opens a window for administrative users to configure the system settings such as creating/modifying users, changing the XScribe default settings and protocols, defining archive directories, and so on.
 Exit	Closes the XScribe application and returns the user to the desktop.
	Allows users to Minimize or Exit the application and return to the desktop.

## XScribe Technical Specifications

Features	Specifications*
<b>Operating System</b>	Microsoft® Windows™ 7 Professional 32-bit
<b>Input Channels</b>	Simultaneous acquisition of all 12 leads
<b>Standard Leads Acquired</b>	I, II, III, aVR, aVL, aVF, V1, V2, V3, V4, V5, V6
<b>Display</b>	24" flat panel color monitor with 1920 x 1080 resolution
<b>Exercise Equipment Interface</b>	Digital serial interface to treadmill or ergometer
<b>Automatic Blood Pressure Measurement Option</b>	Optional interface to external automatic BP device; SpO <sub>2</sub> available on certain devices
<b>Remote Keypad Option</b>	Optional remote keypad interface for operation of treadmill, printing of 12-lead rhythm strip, or NIBP acquisition
<b>Remote Review Workstation Option</b>	Optional remote review workstation for review, printing, and editing of patient test data acquired from XScribe system
<b>Input Dynamic Range Electrode Tolerance Common Mode Rejection Frequency Response</b>	Meets or exceeds the requirements of ANSI/AAMI EC11
<b>X12+/M12A Digital Sampling Rate</b>	10,000 s/sec/channel used for pacemaker spike detection; 500 s/sec/channel used for recording and analysis
<b>AM12 Digital Sampling Rate</b>	40,000 s/sec/channel used for pacemaker spike detection; 500 s/sec/channel used for recording and analysis
<b>Network Option</b>	Optional network interface for data export and printing across local network
<b>Device Classification</b>	Class I, Type CF defibrillator-proof applied parts
<b>Printer Options</b>	High-speed LaserJet printer or thermal array with 200 dots per inch; network print capability; electronic final report export local or via network.
<b>Data Acquisition</b>	Direct connection using Welch Allyn's AM12 or M12A patient cable; wireless connection using Welch Allyn's X12+ transmitter
<b>External Output</b>	TTL and analog output
<b>Power Requirements</b>	110-240 VAC at 50/60 Hz
<b>Power Requirements for Isolation Transformer</b>	1000VA rating; Maximum Current Input of 8.5A at 115V; Maximum Current Input of 4.2A at 230V; Maximum four pieces of equipment connected at once
<b>Power Requirements for Optional Laser Printer</b>	Maximum power draw of 800W
<b>Power Requirements for Optional Tango NIBP/SPO2</b>	Input: 90-250 VAC at 47-63 Hz. Output : 9VDC

## XScribe Hardware Specifications

Feature	XScribe Workstation Minimum Specifications*
CPU	HP rp5800 model
Processor	Intel Core i3
Operating System	Microsoft Windows 7 32-bit Professional
Graphics	1920 x 1080
RAM	4 GB
Hard Drive Capacity	500 GB
Archive	Network or external USB drive
Input devices	USB Standard keyboard and scroll mouse
Software Installation	CD-ROM
Network	100 Mbps connection or better
Printing Devices	HP M401n LaserJet printer (to fit in cart) Z200+ thermal printer (requires additional network port)
USB ports	2 free USB 2.0 ports
Serial Ports	2 serial ports required for digital interface
Chassis H x W x D	3.95 x 13.3 x 14.9 inches 100 x 338 x 379 millimeters
Audio	Required for NIBP and Pharmacological notification
<b>Isolation Transformer Required When Workstation Is Used For Stress Testing</b>	
Isolation Transformer Requirement	Known Agency Mark (KAM) Meets IEC 60601-1 requirements Protective Earth conductor for all connected equipment Z200+ only configuration: 300 watts LaserJet printer configuration: 1,000 watts

\* Specifications subject to change without notice.

Feature	XScribe Server Minimum Specifications*
Processor	Performance equivalent to an Intel Xeon class, Quad-core with hyperthreading
Graphics	1024 x 768
RAM	4 GB
Operating System	Microsoft® Windows™ 2008 server R2 Service Pack 1, 64-bit (required)
System Disk	100 GB for OS and product installation (RAID recommended for data redundancy)
Data Disks	550 GB hard drive space available HD controller with 128 MB read/write cache (RAID recommended for data redundancy)
Archive	Network or external USB drive
Software Installation	CD-ROM
Network	100 Mbps connection or better
Input devices	Standard keyboard and mouse

\* Specifications subject to change without notice.

## M12RFXXX-USB Block Diagram

The M12RFXXX-USB is the wireless version of the M12C-USB. This unit allows the use of the X12 or X12+ Transmitter to input the ECG signal from the patient into the XScribe Stress System. The M12RFXXX-USB comes in two different version, the M12RF2500-USB for use with the X12 and X12+ 2500MHz transmitters and the M12RF608-USB for use with the X12+ 600MHz transmitters. The design of the M12RFXXX-USB is such that it will allow ECG input from either a M12A or M12B or the X12 or X12+.

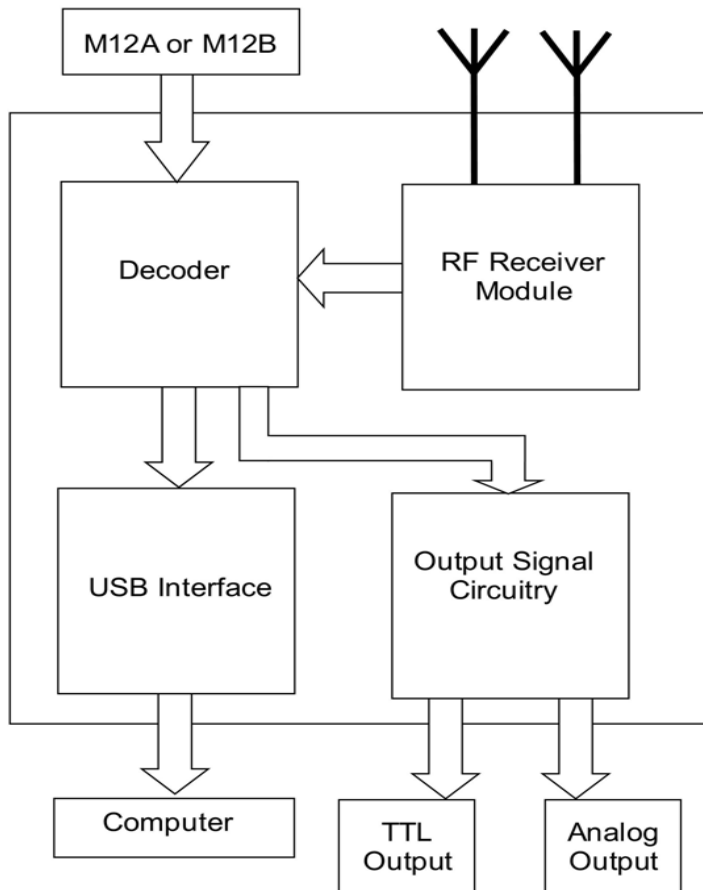

## M12C-USB and M12RF-USB Input Connections

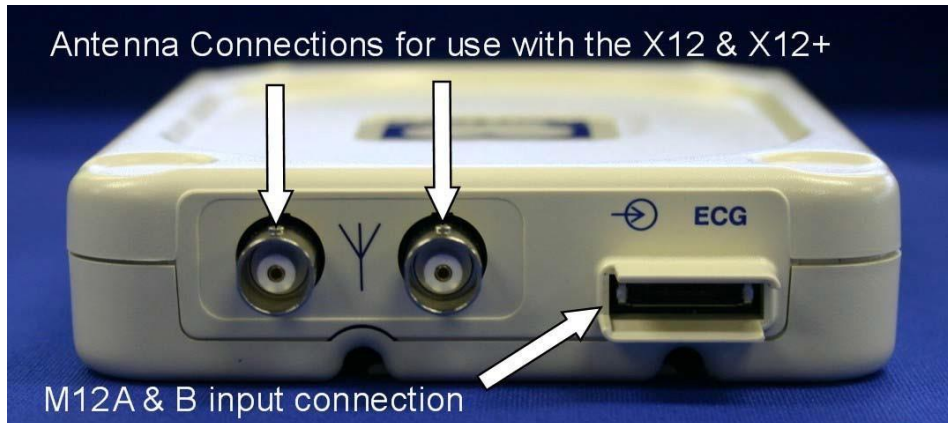

## M12C-USB and M12RF-USB Output Connections

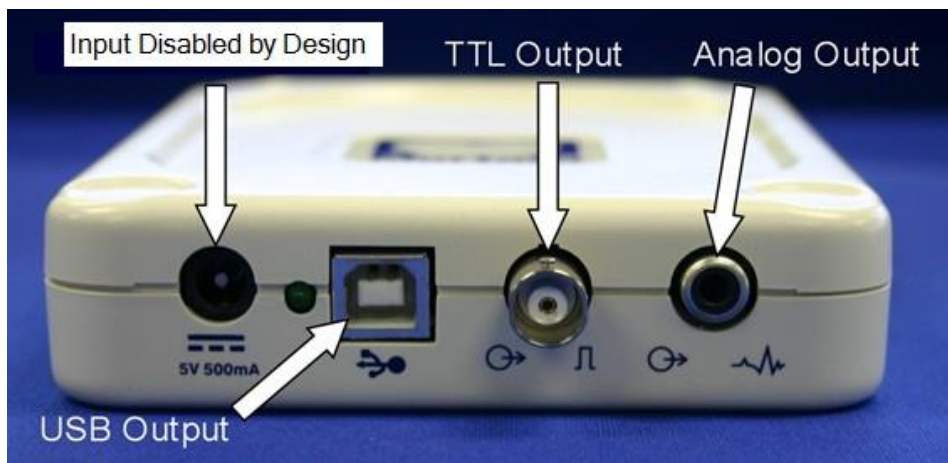

Note: Devices connected to the TTL output and the Analog output of the M12C-USB and the M12RF-USB must be IEC60601-1 compliant.



## Medical Isolation Transformer



Medical Isolation Transformer

### Specification:

Frequency:	50/60 Hz
Output Ratings:	115/230V 1000VA
Weight:	22 lbs. (9.98 kg)
Dimensions:	Height = 5.1" (130 mm)
	Width = 8.0" (203 mm)
	Depth = 11.0" (280 mm)

REF: 1404-002	Input 115VAC 50/60 Hz 2x10AT Fused
REF: 1404-003	Input 230VAC 50/60 Hz 2x6.3AT Fused



**CAUTION:** Before connecting system components to the isolation transformer, ensure the voltage selector (located above the power cord) matches the line voltage.

**CAUTION:** Risk of electrical shock. Do not remove cover. Refer servicing to qualified service personnel. Grounding reliability can only be achieved when system components are connected to an equivalent receptacle marked "hospital grade."

**CAUTION:** Use of this transformer with equipment other than originally supplied, or surpassing the ratings, may cause damage, fire, or injury.



**WARNING:** Possible explosion hazard. Do not use in the presence of flammable anesthetics.

## Treadmill

The treadmill models currently used with the Scribe 5 Stress test system are Full-Vision TrackMaster TMX-425 or FVX-328.



Please refer to the treadmill owner's manual that came with the treadmill for maintenance information.

**\*Note – The treadmill MUST be connected to a dedicated mains outlet.**

## Historical Reference Tables:

### Patient Cable Input to Computer Input Compatibility

The following table shows compatibility of the above computer input devices.

<b>Computer Input Device</b>				
<b>Patient Cable Input</b>	M12C-USB	M12RF2500-USB	M12RF600-USB	CPU USB Port
M12A	<b>Yes</b>	<b>Yes</b>	<b>Yes</b>	-
X12 2500	-	<b>Yes</b>	-	-
X12+ 2500	-	<b>Yes</b>	-	-
X12+ 608	-	-	<b>Yes</b>	-

### Computer Input to Computer Operating Systems Compatibility

<b>Computer Input Device</b>	<b>Operating system(s)</b>
M12RF2500-USB	Windows XP SP2 (Service Pack 2 and above), Windows 7 32-bit
M12RF600-USB	Windows XP SP2 (Service Pack 2 and above), Windows 7 32-bit
M12C-USB	Windows XP SP2 (Service Pack 2 and above), Windows 7 32-bit

### Printer Compatibility to Operating System Compatibility

The following table lists compatibility of the Z200 and Z200+ Thermal Printers with the operating systems.

<b>Printer</b>	<b>Operating System(s)</b>
Z200+	Windows 98, 2000, XP, Windows 7 32-bit
Laser Printer*	Windows 95, 98, 2000, XP, Windows 7 32-bit

\* Laser Printer: Any laser printer supported by the Windows Operating System should work properly. It is however recommended to test any printer before making a final standard decision. Please note that compatible printers will differ in the printing speed and this may affect the continuous printout function offered by the system. The HP 1100 is considered the low-end printer type and it barely allows continuous printouts. The HP 4000 series are high-speed printers and allow continuous printouts.

## XScribe 5 Output Signals

The following table describes the output signals that the XScribe system can produce for interfacing to other devices.

<b><i>Scribe 5 computer input device</i></b>	<b><i>Output signal</i></b>	<b><i>Method of connection to external device</i></b>
M12C-USB	TTL Analog	BNC connector on M12C-USB RCA connector on M12C-USB
M12RF-USB	TTL Analog	BNC connector on M12C-USB RCA connector on M12C-USB

## XScribe 5 Software Version Compatibility with Operating System

<b><i>XScribe Software Version</i></b>	<b><i>Operating System</i></b>
XScribe 5 Version	Windows 7 32-bit

## XScribe 5 Software / USB Driver Information

<b><i>XScribe Software Version</i></b>	<b><i>Supplied Driver</i></b>	<b><i>M12C/M12RF-USB</i></b>
XScribe 5.xx	2.00.01	Yes

# MAINTENANCE & CLEANING

---



**WARNING:** Preventive maintenance is to be performed by Welch Allyn authorized service personnel only.

## Maintenance Procedure

Welch Allyn recommends device maintenance is performed on an annual basis.

### Equipment needed:

- Treadmill PM KIT
  - 1/4" Nut Driver
  - 3/8" Allen Wrench
  - 1/4" T-style Allen Wrench
  - 1/2" Combination Wrench
  - Tube of TrackMaster Grease (or equivalent)
  - RS-232 Treadmill Test Plug
  - Treadmill Test Program
- Clean, lint-free cloth
- Cleaning solvent (isopropyl alcohol, 70%)
- DRY, low pressure, compressed air (30 psi)
- Masking tape
- Rubber Rejuvenator/Platen Cleaner
- Screwdriver Philips #2
- Safety Analyzer

## Treadmill Preventive Maintenance

***Refer to the service manual for the treadmill model utilized with the XScribe system for preventive maintenance information. The following list of activities should be performed to properly maintain and verify proper treadmill operation.***

Treadmill Inspection/Maintenance:

- Running Belt Cleaning & Inspection
- Running Belt Tension Check/Adjustment
- Drive Belt Tension Check/Adjustment
- Elevation Screw Lubrication
- Control Cable Fastened/Routed Appropriately

Treadmill Functional Testing

- Test Plug Operation
- XScribe Control Test
- Emergency Stop Button Check

## XScribe System Preventive Maintenance and Cleaning

### Mounting of Antennas / Receiver Module / Direct Connect Module

Verify that the system antennas, receiver module, and/or direct connect module are properly mounted or located on the XScribe cart for optimum performance. The cables and positioning of these devices should be such that they do not interfere with the operator of the system, and do not cause a potential hazard to anyone who is walking nearby or around the system. In the case of the direct connect module, a strain relief should be provided to prevent the USB cable connector from being damaged due to accidental tension being applied to the cable from the module to the PC.

### System PC Cleaning



Remove and open the system PC from the transport cart. Using a vacuum or compressed air, remove any accumulated dust and debris from the PC. Take particular care to cleaning around cooling fans and inside media access slots (refer to cooling fan inspection below). Clean the cart area that the PC and peripheral equipment reside in, to prevent dust and debris accumulation from occurring. Reinstall the PC into the transport cart once completed.

#### Inspection of PC cooling fans

Inspect CPU fan, and power supply fan. If they are running too slowly or are making any unusual noises during operation, they should be replaced. For improperly operating PC power supply fans, Welch Allyn recommends replacing the entire power supply unit.

### Monitor Cleaning

**WARNING:** To avoid risk of electric shock and damage to the monitor, do not disassemble the monitor cabinet. The unit is not user-serviceable. User maintenance is restricted to the following cleaning instructions.

Unplug the monitor from the power outlet before cleaning.

- To clean your monitor screen, lightly dampen a soft, clean cloth with water or mild detergent. If possible, use a special screen cleaning tissue or solution suitable for the anti-static coating.
- To clean the monitor cabinet, use a cloth lightly dampened with mild detergent. Make sure that water cannot drip into the case of the monitor.
- Wipe off stubborn stains from the cabinet or screen with a cloth lightly dampened in isopropyl alcohol. Do not use benzene, thinner, ammonia, or abrasive cleaners.

### Keyboard/Mouse Cleaning

Turn the keyboard upside down. Gently tap the back of the keyboard and press the keys to release any debris from in between the keys.

If you have a can of compressed air then use it to blow any debris from around and under the keys, if not then use the hose of a vacuum cleaner to remove it.

If the keys appear to need cleaning, use a cotton swab with isopropyl alcohol on it to clean the sides of the keys as needed.

After cleaning the sides of the keys take your lint free cloth and dampen it with isopropyl alcohol (don't put the liquid directly on the keyboard), give the surface of the keyboard a good wipe over using the cloth to trace the contours of the keys. Use the damp cloth to gently wipe the mouse to remove any hand oils or debris that may be present.

## **XScribe Cart Cleaning**

Use a damp, clean cloth to wipe off external surfaces with isopropyl alcohol. Do not use solvents, or cleaning solutions that may damage the surface of the instrument. Avoid contact with open vents, plugs, and jacks.

## **Cable Management**

Arrange the PC interconnect cables in an orderly manner to prevent any of the cables from becoming stressed or dislodged over time. Cable ties and/or fasteners can be used to manage systems that have a significant amount of interconnecting cables to the PC and isolation transformer.

## **Thermal Writer Cleaning**

Use a damp, clean cloth to wipe off external surfaces. Open the writer door and use masking tape to clean the platen of the thermal writer. The platen should then be further cleaned with a Rubber Rejuvenator/Platen Cleaner to ensure it does not deteriorate over time. The thermal print head can be cleaned using a clean lint free cloth and isopropyl alcohol; simply wipe the print head surface that makes contact with the paper to remove any debris or residue that may have built up during operation.

## **System Checks**

### **Archive Management**

With customer's assistance, create additional Archive folders on the root directory or on the network (if option installed). Refer to the X-Scribe User Manual (9515-151-50-ENG) for complete instructions. Archive all the patient exams from the root Archive to the newly created Archive locations.

### **Hard Drive Space**

Check the capacity of the system hard drive to ensure there is sufficient space for system operation. If the system drive is nearing capacity (approaching 90%), this issue should be discussed with the facility to create additional space for proper operation. If the drive was near capacity and unnecessary files were removed, a defragmentation may be performed to ensure optimal performance of the drive.

*Note: The defragmentation process may take several hours and is only required in extreme cases.*

### **Z200+ Writer Test**

Using the Z200Plus Monitor software, print off a test page. The Z200PlusMonitor software can be loaded onto the XScribe system or ran from USB stick. Double click Z200PlusMonitor icon to launch the application. Press Connect and then press Print Test Page. Verify on the print out page that there are no missing pixels or light printing. Now press Disconnect and close the application.

## **Conformance Testing**

### **Transmitter(s) and Patient Cable(s)**

Verify patient cable connector pins are not bent by disconnecting patient cable from transmitter and observing. Connect transmitter to a patient simulator. Then perform a lead check as described in X12+ User Manual (9515-164-50-ENG) or T12 User Manual (9515-173-50-ENG). Wiggle patient cable to verify lead wires are not broken.

### **Stress Test**

Connect a patient simulator to the transmitter. Start a New Exam and let the system go through a complete Bruce protocol test. Verify that treadmill speed and elevation increase with each stage. Verify that printouts are coming out the Z200+ writer. Verify you do not see any square waves on the display of the XScribe system.

### **Data Export (if option installed)**

Verify XScribe is able to Export pdf's, xml, tif, DICOM, etc to the network. Verify XScribe is able to download a worklist from the network.

## **Safety Testing**

The following safety tests should be performed in accordance with IEC 60601 or IEC 62353 standards and all local regulatory requirements:

- Earth Leakage (performed on medical isolation transformer)
- Enclosure Leakage (performed on medical isolation transformer)

*The following safety tests are required only for systems utilizing a wired patient interface.*

- Patient Leakage
- Patient Leakage Type-F
- Patient Auxiliary Current



**Welch Allyn Inc.**

Welch Allyn, Inc.  
4341 State Street Road  
Skaneateles Falls, NY 13153

Phone (414) 354-1600  
Fax (414) 354-4760

**XScribe Preventive Maintenance Report**

XScribe Serial #: \_\_\_\_\_

Treadmill Serial #: \_\_\_\_\_

- Treadmill Inspection / Maintenance
  - Running Belt Cleaning & Inspection
  - Running Belt Tension Check / Adjustment
  - Drive Belt Tension Check / Adjustment
  - Elevation Screw Lubrication
  - Control Cable Fastened/Routed Appropriately
- Treadmill Functional Testing
  - Test Plug Operation
  - X-Scribe Control Test
  - Emergency Stop Button Check

- Visual Inspection/Cleaning
  - Verify antennas or direct connect module are properly mounted
  - Inspect/Clean system PC, monitor, keyboard and mouse
  - Inspect/Clean any adhesive residue or scuff marks from transport cart
  - Organize/fasten interconnect cables on cart
- Thermal Writer Cleaning (if option installed)
  - Platen Cleaning
  - Thermal Printhead Cleaning
- System Checks
  - Archive management
  - Sufficient hard drive space
  - Print writer test page and inspect for proper operation/darkness
- Conformance Testing
  - Perform lead check on system transmitter(s) and patient cable(s)
  - Perform a full stress test with a patient simulator
  - Verify treadmill turns on as per protocol settings
  - Verify writer prints as per protocol settings
  - Verify data export functionality (if option installed)
- Safety Testing
  - Earth Leakage
  - Transformer Enclosure Leakage
  - (The following tests are performed for wired patient inputs only)*
  - Patient Leakage
  - Patient Leakage Type-F
  - Patient Auxiliary Current

Technician or Field Service Engineer: \_\_\_\_\_ Date: \_\_\_\_ / \_\_\_\_ / \_\_\_\_

# DEVICE CONFIGURATION

## Administrative Tasks

The IT and Clinical Administrator user will select the **System Configuration** icon to enter the XScribe administrative functions. All other users can enter this menu to access the Export Service Log task only.

A list of administrative tasks is presented to:

- Manage user accounts
- Manage personnel lists
- Manage Groups
- Manage archived exams \*
- View audit trail logs
- Export service logs for troubleshooting purposes
- Configure system-wide modality settings
- Configure DICOM data exchange
- Configure XML and PDF data exchange
- Configure workflow
- Unlock exams

\* Task may not be available when operating with DICOM.

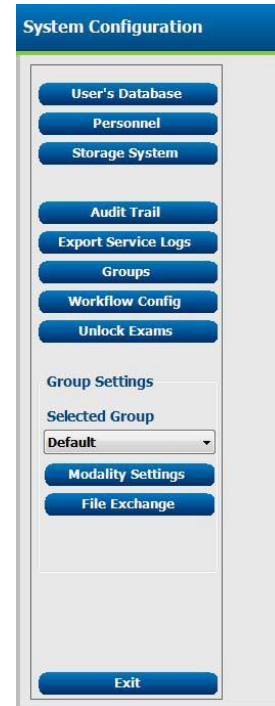

## Manage User Accounts

### User's Database

The IT administrator will select **User's Database** to create or remove user accounts, reset user passwords, assign permissions for each user, and assign personnel entries for that user's selection. When a single sign-on is used, no user account and password creation is needed.

User ID	Username	Name	Roles
5	Schedule	Scheduling Person	Schedule Procedure
3	IT	IT Administrator	IT Administrator
1	admin	All Roles Selected	IT Administrator, Clinical Admin, Schedule Procedure, Patient Hookup,
4	Clinical	Clinical Administrator	Clinical Admin
6	Hookup	Hookup Technican	Patient Hookup
7	Review	Review Report and Export	Review Report, Export Report
11	Export	Export Report Person	Export Report
12	View	View Exams and Reports Only	View Exams/Reports
8	Sign	Sign Report Doctor	Sign Report

### Personnel

**Personnel** is selected to add personnel that will be available in the Patient Information, Summary, and the Finalize Exam Update windows. Listed personnel can be assigned to each user account and will appear as selections for the logged-in user and in the appropriate final report fields.

Printed Name	Staff ID#	Enabled	In Reviewer List	In Technician List	In Attending Phys List
Dr. Henry Ford	101	<input checked="" type="checkbox"/>	<input checked="" type="checkbox"/>	<input type="checkbox"/>	<input checked="" type="checkbox"/>
Dr. Harry Fuller	102	<input checked="" type="checkbox"/>	<input checked="" type="checkbox"/>	<input type="checkbox"/>	<input checked="" type="checkbox"/>
Dr. Norman Black, Fell...	103	<input checked="" type="checkbox"/>	<input checked="" type="checkbox"/>	<input type="checkbox"/>	<input type="checkbox"/>
Dr. William White, Fell...	104	<input checked="" type="checkbox"/>	<input type="checkbox"/>	<input type="checkbox"/>	<input type="checkbox"/>
Mary Sebig, RN	105	<input checked="" type="checkbox"/>	<input checked="" type="checkbox"/>	<input checked="" type="checkbox"/>	<input type="checkbox"/>
Barbara Smith, PA	106	<input checked="" type="checkbox"/>	<input checked="" type="checkbox"/>	<input type="checkbox"/>	<input type="checkbox"/>
John Hammond, CVT	107	<input checked="" type="checkbox"/>	<input type="checkbox"/>	<input checked="" type="checkbox"/>	<input type="checkbox"/>
Nancy Fredericks, RCVT	108	<input checked="" type="checkbox"/>	<input type="checkbox"/>	<input checked="" type="checkbox"/>	<input type="checkbox"/>
Dr. Smith	100	<input type="checkbox"/>	<input type="checkbox"/>	<input type="checkbox"/>	<input checked="" type="checkbox"/>

## Manage/Create Groups

Groups allow the administrator to group exams according to reporting preferences (modality settings) and file exchange preferences. A single default group exists that can be copied and saved with a new name to create a second group. Select **Groups** to make a change. Any created group can be copied, renamed and modified. The Default group can be renamed. An unlimited number of groups can be created and modified.

XScribe Modality Settings and File Exchange paths can be uniquely defined for each individual group.

Groups, with exception of the Default group, can be deleted resulting in deletion of all exams that exist within the deleted group.

## Modality Settings

XScribe modality settings are defined as default by the clinical administrator and are available for the user with editing permissions. The user is able to modify these settings on a per exam basis. Select the tab you wish to modify and click on **Save Changes** or **Discard Changes** to cancel changes before exiting.

### Profile

The Profile for the factory default group can be modified according to physician and user preferences. A single profile that contains four tabs, described below and on the following page, is defined per group.

### Real Time Display

Use the drop-down lists to select the **Waveform** speed, gain, **Lead Layout**, **Lead Mode** and 3 or 6 leads for display.

40 Hz, Source Consistency (SCF<sup>©</sup>), and AC filters are enabled by check box.

Choose the **Context View On** check box to enable and select the default lead from the drop-down list.

**Standard** or **Cabrera** lead mode can be selected.

Enable **ST-Lead** by checkbox and use the drop-down list to select the default for the 4x QRS window. When Dynamic is selected, the lead with the most significant ST change is displayed.

Choose the desired radio button for the **Event Display**.

When the **Trend Display** is enabled, the HR, METs, NIBP, and ST running trends are displayed during the test.

## Printout

Use the drop-down lists to select the ECG Print **Speed**, **Format**, and **Printer Type** for 12-lead ECG printouts. Grid can be enabled for windows printers. Choose the Rhythm Lead from the drop down and enable Zoom ST Lead and 12 Lead Average as desired.

Use the drop-down lists to select the Event Print **Speed**, **Format**, and **Printer Type**. Grid can be enabled for windows printers. Choose the Rhythm Lead from the drop down.

Use the drop-down lists to select the Continuous Print **Speed**, **Format**, and **Printer Type** for 12-lead ECG printouts.

The screenshot shows the 'Printout' tab in the configuration menu. It is divided into three sections: ECG Print, Event Print, and Continuous Print. Each section has dropdown menus for Speed, Format, and Printer Type, and checkboxes for Grid, Rhythm Lead, Zoom ST Lead, and 12 Lead Average.

## Rhythm Events

Use the up/down arrows to select the maximum number of events stored during pre-exercise and PVCs per minute events, maximum couplets per minute, and maximum ventricular runs per minute during exercise.

Use **Add** or **Delete** to modify the Event Labels list.

**NOTE:** *Bookmark, Supine, Mason-Likar, Standing, and Hyperventilation event labels are listed by default and cannot be edited or deleted.*

**NOTE:** *XScribe automatically detects an arrhythmia event. It is stored, can be displayed on trends display, and printed if Arrhythmia Printouts is enabled in the Softkey pop-up menu.*

The screenshot shows the 'Rhythm Events' tab. It features four spinners for 'Max Pre-Exe Events', 'Max PVC/Min Events', 'max Couplet/Min', and 'Max VRun/Min'. To the right is a list of 'Event Labels' with 'Add' and 'Delete' buttons, and a text input field for 'Leg Claudication'.

## Miscellaneous

Use the drop-down lists to select the **Treadmill Speed Units** and **RPE Scale** type.

Choose Automatic or Manual **Blood Pressure** radio buttons.

Choose Normal or Bold **Waveform Print**.

Use checkboxes to enable display of ST/HR Index, Double Product, METS, SpO2, Duke Score and FAI Score.

Use drop-down lists to select Male Max HR formula, Female Max HR formula, and ST Units in mm or  $\mu$ V.

Use up/down arrows to choose ST post-J measurement in milliseconds.

The screenshot shows the 'Miscellaneous' tab. It includes dropdowns for 'Treadmill Speed Units' and 'RPE Scale', radio buttons for 'Blood Pressure' and 'Waveform Print', and several checkboxes for 'Display ST/HR Index', 'Display Double Product', 'Display METS', 'Display Sp O2', 'Display Duke Score', and 'Display FAI Score'. It also has dropdowns for 'Male Max HR Formula' and 'Female Max HR Formula', and spinners for 'ST Units' and 'J-ST'.

## Protocols

Users can **Add Protocol** to create a copy of the selected protocol, **Delete Protocol** and **Reset to Factory Default**. The **Add Protocol** button will create a copy of the selected protocol that can be edited and renamed. All added protocols will be deleted by selection of the **Reset to Factory Default** button.

The Protocols tab selections are related to each selected Protocol Name. Choose from the Protocol Name drop-down list to edit the stage settings for that protocol. Select the **Save Changes** button prior to exiting, or the **Discard Changes** button to cancel your edits.

**Protocol Name** — Use the drop-down menu to select a specific protocol.

**Equipment** — Displays the exercise equipment associated with the selected protocol.

**Pharmacological** — A dose setting is included that when selected prompts the system to display a pop-up window notifying the clinician that a next-dose administration may be required.

**Add Protocol** — Adds an additional protocol requiring the user to complete fields on the 3 tabs: **Pre-Exercise**, **Exercise**, and **Recovery**.

- Type a name for the new protocol
- Select the equipment associated with the new protocol

**NOTE:** Refer to your treadmill/ergometer documentation to check models supported by XScribe, or contact Welch Allyn Technical Support for assistance.

## Pre-Exercise

- Speed/Grade or Power: use the up/down arrows to define treadmill speed and grade, or ergometer power in watts.

## Exercise

- Use the **Add Stage** to define the number of exercise stages needed. A maximum of 60 stages at a maximum stage time of 30 minutes per stage and a minimum stage time of 15 seconds per stage may be defined for each protocol.
- Select the **Action** to define ECG Print, BP measurement, and Dose **By Stage** or for the **Entire Exercise** starting at mm:ss every mm:ss independent of stage durations.

**Entire Exercise**

	Print	BP
Every	Every	Every
Starting	2:00	5:00
	1:00	5:00

Stress System Settings

Profiles Protocols

Equipment:  Treadmill  Ergometer

Protocol Name: Bruce Add Protocol Delete Protocol

Pharmacological  MPH  km/h Reset to Factory Default

Pre-Exercise Exercise Recovery

Action  By Stage  Entire Exercise

Stage	Length	Speed	Grade	Print	BP
Stage 1	3:00	1.7	10.0	End	End
Stage 2	3:00	2.5	12.0	End	End
Stage 3	3:00	3.4	14.0	End	End
Stage 4	3:00	4.2	16.0	End	End
Stage 5	2:00	5.0	18.0	End	End
Stage 6	2:00	5.5	20.0	End	End

Add Stage Edit Stage Delete Stage

To define a stage, highlight and click **Edit Stage**.

- Time/Speed/Grade or Power: use the up/down arrows to define stage length, and treadmill speed/grade, or ergometer power in watts.
  - set Time in increments of five seconds, starting at 10 seconds.
  - set treadmill speed from 0.0 to 12.0 mph, and 0.0 to 19.3 kph.
  - set treadmill grade from 0° to 25° elevation.
  - set ergometer power starting at 10 watts.
- ECG Print/BP Measure: use the drop-down menus to define when to print an ECG and/or prompt for a blood pressure reading.
  - to print/prompt at the beginning of a stage, select Begin.
  - to print/prompt at the end of a stage, select End.
  - select Off for no print/prompt.
  - select Every to manually define the print/prompt time. Use the upper portion of the time selection to define frequency; use the lower portion to define when.
- Dose: use the drop-down menu to define when to administer the next pharmacological stage. Settings available are the same as for ECG Print/BP Measure above.

**NOTE:** When using a device to acquire a BP measurement at the beginning of a stage, XScribe will start BP acquisition immediately upon stage start. When acquiring a BP measurement at the end of a stage, XScribe will start acquisition one minute before stage end enabling the BP measurement to be printed on the ECG printout. If XScribe does not receive the BP measurement within the one-minute time period, the BP measurement will not appear on the ECG printout.

## Recovery

- Number of Stages: use the up/down arrows to define the number of recovery stages needed. A maximum of 60 stages at a maximum stage time of 30 minutes per stage and a minimum stage time of 15 seconds per stage may be defined for each protocol.

Define individual stages in the same manner as for Exercise.

The screenshot shows the 'Recovery' configuration tab. It features a table with columns for Stage, Length, Speed, and Grade. Below the table are buttons for 'Add Stage', 'Edit Stage', and 'Delete Stage'. At the bottom, there are settings for 'Entire Exercise' with dropdown menus for 'Print' and 'BP', and time selection fields for 'Every' and 'Starting'.

Stage	Length	Speed	Grade
Stage 1	1:00	1.5	0.0
Stage 2	9:00	0.0	0.0

Entire Exercise

	Print	BP
Every	Every	Every
Starting	3:00	3:00
	2:00	1:00

## File Exchange

XScribe supports the ability to import orders from XML files and export PDF and XML results to an external system dependent on the system activated features. Import/Export directories for the selected group are defined in the File Exchange window. The Site Number field is not applicable to XScribe. Refer to the Scribe Data Exchange Administrator Manual (P/N: 9515-185-51-ENG) for external system integration details.

### PDF File Name

The final report PDF file name will have the following structure:

```
X<FileType>_EXMGR<Group>_<PatID>^<LName>^<FName>^<MName>_
<TestDateTime>_<ReportDateTime>.XML
```

## DICOM Settings

XScribe supports the ability to exchange information with DICOM systems dependent on the system activated features. A DICOM Modality Worklist (MWL) will be received from the DICOM server. A DICOM encapsulated PDF will be exported to the defined destination. Refer to the Scribe Data Exchange Administrator Manual (P/N: 9515-185-51-ENG) for DICOM connectivity configuration details.

## Unlock Exams

XScribe internally tracks transitioning exams preventing the same exam to be processed by two or more users. When a second user attempts to access an exam in use, a message displays with notification that the exam is not currently available.

As a measure for recovering locked exams, administrative users can unlock an exam that resides on the same workstation by selecting **Unlock Exams**. Highlight the listed exam(s) and click on **Unlock**.

## Manage Archive Storage

The XScribe administrative user will manage storage system disks through selection of **Storage System**.

### Add Archive Location

Select **Mount Remote Disk** to open a window allowing entry of a path to the archive directory destination. Any external disk (e.g. NAS, USB, etc.) accessible from the XScribe central database is a candidate for becoming an archive volume. A Username, Password and Domain must be entered to **Add** the new storage disk to the Available Disks listing. Select **Cancel** button to exit this window without saving changes.

### Restore Archived Exams

Administrative users can restore exams from the archive location to the XScribe database through selection of **Archive Recovery**. Once selected, a window will open listing exam archive date and time, archive name, volume name, volume ID, and drive letter of the archive volume. To restore exams, highlight the desired exam(s) in the list and click on **Recovery**. Multiple exams can be restored by highlighting them and then a single Recovery button click.

**Search** can be used to find exams matching alphanumeric text entry. Column headers can be selected to sort listed exams by that item.

## Audit Trail Logs

The XScribe administrative user will select **Audit Trail** to view the audit trail history. A selection of filter criteria is available to sort the listing by date, user, workstation, operation, or target (e.g. User, Patient, Exam, Conclusion, Locked Exams, User and System Settings). One or two filter criteria can be used to find audit trails.

Selection of results will display the differences by comparing the XML statistics data before and after changes. A legend with colored highlighting will point to added, removed, changed, and moved information.

All configuration information, user information, patient demographic information, exam demographic information, textual conclusions, archive operations, and exam download requests are tracked by the audit trail.

## Service Logs

All XScribe users have access to **Export Service Logs**. Selection of the button creates a Win-7 zipped file that can be sent to the desktop containing a copy of the system logged events.

The file named EMSysLog.xml.gz can be e-mailed to a Welch Allyn service representative for troubleshooting purposes.

## Configure Workflow

The XScribe exam states are designed to follow typical user workflow. There are five possibilities with meanings defined below each state:

1. **ORDERED**  
The stress exam is either scheduled by a user or an external scheduling system has sent an order.
2. **ACQUIRED**  
The stress exam is completed at the XScribe system and is ready for editing.
3. **EDITED**  
The stress exam has been analyzed with or without changes and is ready for review by a physician. Conclusions may be entered at this state.
4. **REVIEWED**  
The stress exam has been reviewed and confirmed to be accurate by an authorized user (e.g. physician, fellow, clinician, etc.). Conclusions may be entered at this state.
5. **SIGNED**  
The exam is reviewed and electronically signed by an authorized user. No further workflow processing is required. Conclusions may be entered at this state.

The user with appropriate permissions is prompted with a Final Exam Update dialog to confirm or Update the next logical state when exiting a stress exam. A drop-down menu allows selection of a state in respect to the exam's current state. **Cancel** may be selected to discard any change to the state.



## Workflow Config

A Legal Signature can be enabled by selecting **Yes** or disabled by selecting **No**. Administrative users can configure the workflow to include all, or exclude some states through selection of **Workflow Config**.

The screenshot shows two panels. The 'Legal Signature' panel has two radio buttons: 'Yes' (selected) and 'No'. The 'Modality Status' panel has three radio buttons: 'All' (selected), 'No REVIEWED', and 'No EDITED/REVIEWED'.

- Select **All** under Modality Status to enable all six states.
- Select **No REVIEWED** under Modality Status to move the state from EDITED to SIGNED.
- Select **No EDITED/REVIEWED** under Modality Status to move the state from ACQUIRED to SIGNED.

## About the Legal Signature

The legal signature requires the user credentials prior to updating a stress exam when changing to a signed state. When enabled, the user is prompted to authenticate with a user name and password when transitioning to the signed state. Authentication can be entered when a different user is currently logged in. When the correct credentials are not entered, the user will be notified with a message that the “Credentials supplied are not valid.”

When the signing physician has been set up as an Attending Physician under Personnel, the printed name will appear in the XScribe final report on the signature line following the “Signed By:” field label.

## User Preferences

Select the User Preferences icon to open the window. Set selections define the default criteria for the Worklist when the particular user is logged into XScribe. Set selections can be changed when the user enters the Worklist window. The user can also change the password in this window when the system is not set up with a single sign-on.

All users have access to the User Preferences settings but may not have the Worklist available. Those users will only enter this window to change their own password.

There are three possible choices for the Worklist stress exam states that can be enabled or disabled by checkboxes. The choices are dependent on the workflow configuration modality status setting in that Edited or Review may not appear as selections.

1. Acquired
2. Edited
3. Reviewed

There are three choices for a default time filter.

1. All
2. Today
3. Today, Yesterday and Tomorrow

When finished, select **OK** to save changes or **Cancel** to exit the window without saving changes.

XScribe will present the default settings on any of the workstations that the user logs into.

## Report Configuration Tool

XScribe final reports should be configured with the practice name prior to using the system. The default sections for final report inclusion are also customizable within this tool.

Click on the XScribe workstation **Start** menu. Choose **All Programs, Welch Allyn, Inc.** followed by **Report Configuration Tool** to open a dialog window prompting a **Group** choice from a drop-down list. Each group that has been defined will have its own report configuration.

Click on the **Start Wizard** button to open the tool. The **Exit** button will close the tool.

### Configuring the Final Report

Once the tool is opened, the following can be performed:

1. **Hide** final report sections by checkbox selection in the Report Configuration Tool. When the box is checked, the section is disabled as a default; however, the section can be enabled for printing and export when previewing the final report for each individual exam.
2. Enter institution contact information under the **Practice** section.

When finished, click on **Next >** and then **Finish**. **<Back** allows you to return to the previous screen; **Cancel** prompts you with an “Are You Sure” message. Select **Yes** to cancel the changes.

Once finished, the Group selection is still available for you to choose the next group to repeat the steps listed above. When done defining all groups, select the **Exit** button.



## RF Scan for X12+

To reduce the possibility of radio frequency (RF) interference while using the X12+ wireless option, you can use the XScribe to perform an RF Scan for optimal channel selection.

Click on the XScribe workstation **Start** menu. Choose **All Programs, Welch Allyn Modality Manager** followed by **Spectrum Analyzer** to open the Welch Allyn Spectrum Analyzer dialog window. To simplify access, it is recommended to place a shortcut to this tool on the desktop.

The analyzer will scan all channels and display a bar graph showing the RF activity found on each channel. Radio button selections allow choices for each antenna or Best (using both antennas) to search for the channel having the lowest RF activity (smallest graphical bar) and set that channel on both the X12+ transmitter and the XScribe. Channels in the graph can be displayed in Hex or Decimal values using radio button selections as well.

To stop the RF scan, click the **Stop RF Scan** button. To clear the display, click the **Clear** button.

It is recommended to allow the RF Scan to run for a period of time during the times that the possibility for interference is highest. The current RF power is colored amber and the maximum power for each channel is colored red.

The example below shows that the best channel selections would be 16, 32, or 38 for a 608 MHz X12+ transmitter in the WMTS band.

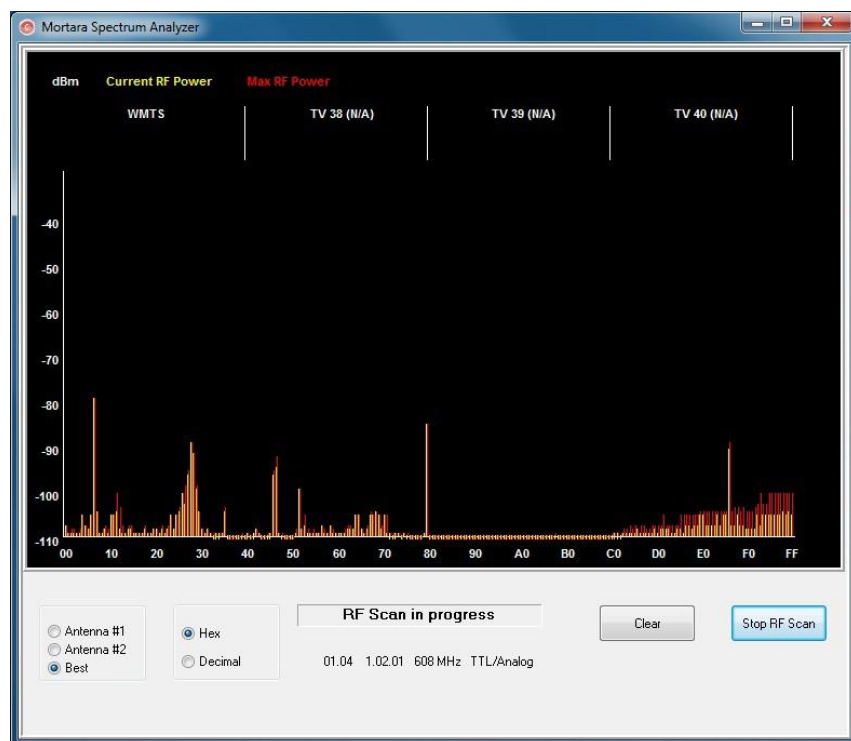

**NOTE:** To change channels on the X12+ transmitter, refer to the device user manual. There are 256 channels available for the 2500 MHz transmitter and 64 channels available for the 608 MHz transmitter in the WMTS band.

## UNIT DISASSEMBLY

---



**(For Welch Allyn Supplied Hardware Only)**

### **Before you begin**

1. Put on your electrostatic discharge (ESD) wrist strap to avoid damaging any circuitry.
2. Remove all devices (such as diskettes and CD-ROMs) from the computer.
3. Power off the computer and any peripheral devices that are connected to it.
4. Disconnect the power cord from the electrical outlet and then from the computer. When the computer is plugged into an AC power source, there is always voltage applied to the system board. You must disconnect the power cord from the power source before opening the computer to prevent system board or component damage.
5. Disconnect all peripheral device cables from the computer.

### **Static electricity**

Static electricity can damage electrical components. Before removing or replacing a component, touch a grounded metal object to discharge static electricity. Also observe the following precautions to prevent damage to electric components and accessories:

- To avoid hand contact, transport products in static-safe containers such as tubes, bags, or boxes.
- Protect all electrostatic parts and assemblies with conductive or approved containers or packaging.
- Keep electrostatic-sensitive parts in their containers until they arrive at static-free stations.
- Place items on a grounded surface before removing them from their container.

- Always be properly grounded when touching a sensitive component or assembly.
- Avoid contact with pins, leads, or circuitry.
- Place reusable electrostatic-sensitive parts from assemblies in protective packaging or conductive foam.

## Disassembly



**WARNING:** Be sure the AC power cord is disconnected prior to performing servicing.

- During disassembly, label each cable as you remove it, noting its position and routing. This will make the replacement of the cables much easier, and will ensure that the cables are rerouted properly to protect the cables.
- Keep all screws with the units removed. The screws used in the computer are of different thread sizes and lengths; using the wrong screw in a component could damage the unit.

### Access panel removal

1. Review the safety considerations before performing the steps listed below by clicking on the following

**CAUTION:** Failure to comply with the *precautions* could result in damage to your product or loss of data.

2. Pull up and hold the access panel release latch.
3. Rotate the panel up and lift it away from the chassis.



To install the computer cover, reverse the removal procedure.

## Front Bezel Removal

1. Prepare the computer for disassembly
2. Remove the access panel
3. Lift up the three tabs on the side of the bezel **(1)**, then rotate the bezel off the chassis **(2)**.

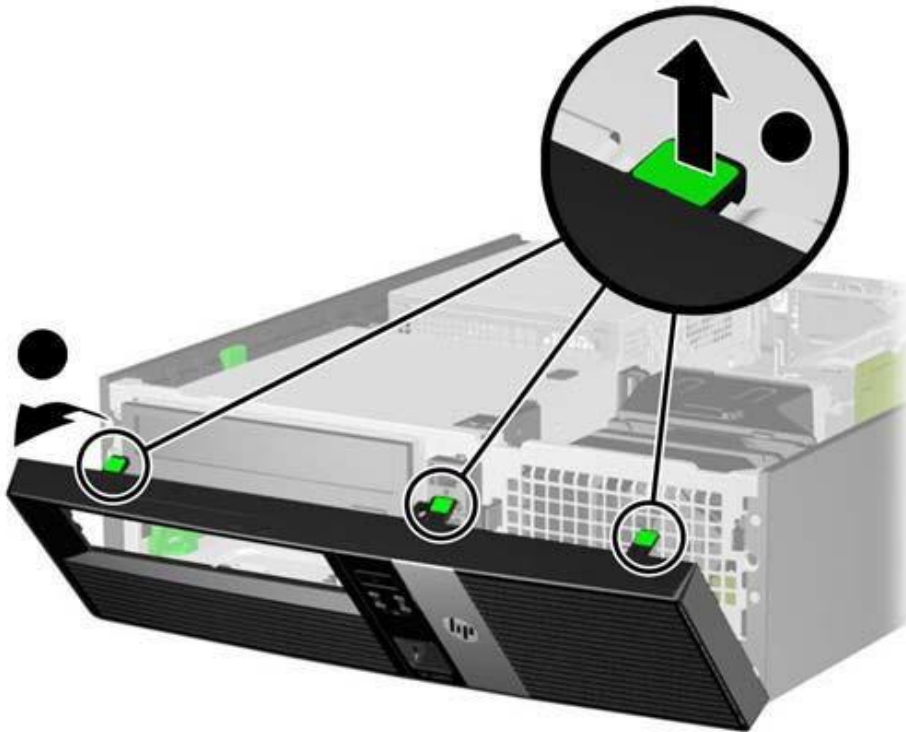

To install the new front bezel, reverse the removal procedure.

## Front Bezel Security

The front bezel can be locked in place by installing a security screw provided by HP.

To install the security screw:

1. Prepare the computer for disassembly
2. Remove the access panel
3. Remove the front bezel
4. Remove one of the five silver 6-32 standard screws located on the front of the chassis behind the bezel.

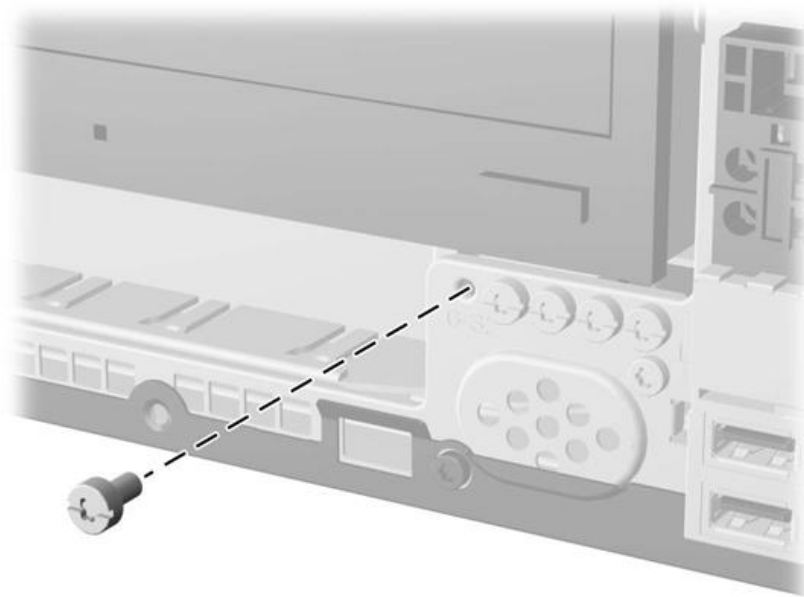

5. Replace the front bezel.
6. Install the security screw next to the middle front bezel release tab to secure the front bezel in place.

To remove the front bezel security screw, reverse the installation procedures.



## Power Supply Replacement



**WARNING:** Be sure the AC power cord is disconnected prior to performing servicing.

1. Prepare the computer for disassembly
2. Remove the access panel
3. Disconnect the cabling from the power supply to the motherboard and other computer sub components
4. Remove the screws that fasten the power supply to the computer chassis

<b>XScribe Item Description Listing</b>		
<b>Item #</b>	<b>Part #</b>	<b>Description</b>
1	1404-002	TRANSFORMER ISOLATION 1000VA MED DOM (110VAC)
2	1404-003	TRANSFORMER ISOLATION 1000VA MED INTN'L (220VAC)
3	25004-003-52	CABLE TRACKMASTER TO CPU X-SCRIBE
4	25004-012-50	CABLE ERGOMETER INTERFACE ERGOLINE
5	30012-021-51	USB TRANSCEIVER KEY (UTK) MODULE RSCRIBE
6	30012-022-51	M12C-USB w/AUX OUTS INTERFACE ASSEMBLY
7	30012-022-61	M12RF611-USB w/AUX OUTS INTERFACE ASSY
8	30012-022-71	M12RF2500-USB w/AUX OUTS INTERFACE ASSY
9	3181-002	POWER CORD INTN'L CEE7/7+IEC320-C13
10	3181-003	POWER CORD BRIDGE 2m IEC320-C13+C14
11	3181-008	POWER CORD US/CAN HOSPITAL 5-15P+320-C13
12	34000-025-1002	Z200+ THERMAL WRITER A/A4
13	3510-005	PLUG TO PLUG ADAPTOR BNC
14	3600-003	ANTENNA TNC 2400MHz 1/2 WAVE LENGTH
15	3600-010	ANTENNA 611MHz BNC 1/4 WAVE
16	3601-001	COUPLER TNC FEMALE TO BNC FEMALE
17	6400-008	CABLE ETHERNET RJ-45M TO RJ-45M STR-THRU
18	6400-010	CABLE ETHERNET CAT5e RJ-45 M SHLD 2FT
19	6400-011	CABLE CROSSOVER CAT5e RJ-45 M SHLD 3FT
20	6400-012	CABLE USB TYPE A-TO-B FULL SPD
21	8342-007-01	SPACER A4 PAPER ELI 200+
22	8346-003-50	X12+ BATTERY DOOR
23	9900-014	MONITOR 24" LCD 1920x1200 WIDE DVI + VGA
24	9906-037	CPU LONG LIFE w/WINDOWS 7
25	9911-012-50	CART X-SCRIBE SYSTEM MPE
26	9911-012-51	STORAGE BIN MPE CART X-SCRIBE
27	9911-012-54	SWIVEL MOUNT BRACKET TANGO MODULE
28	9912-019	CABLE ERGOMETER INTERFACE LODE CORRIVAL
29	9960-051	NETWK CRD PCI 10/100/1000 GIGABIT ETHRNT
30	9960-052	ISOLATOR ETHERNET LOW LEAKAGE RJ45/RJ45
31	SERV PART 151-01	CABLE X-SCRIBE TO SUNTECH TANGO
32	SERV PART 184-01	LONG LIFE PC POWER SUPPLY
33	SERV PART 184-02	PS2 Keyboard & Mouse
34	X12PLUS-XXX-XXXX	X12+ Transmitter

# TROUBLESHOOTING

---

The following is a list of common problems and resolutions that may be experienced. If the problems that you are experiencing are not listed in this table please contact Welch Allyn Technical Support.

## Troubleshooting Chart

<b>Screen Message or Issue</b>	<b>Possible Cause</b>	<b>Solution</b>
<i>Baseline drift</i>	<i>Poor skin-to-electrode contact.</i>	<i>Re-prep skin and replace faulty electrode(s).</i>
<i>BP Printout and Report discrepancy</i>	<i>Use of BP field to enter new blood pressure values.</i>	<i>BP value entry MUST BE completed through the F3 key. Editing of BP is completed through the selection of the BP value on the right side of display. Edited value will erase previously entered value from summary report.</i>
<i>Squared line(s) display on the multi-lead rhythm display screen or on the screen during the exercise test</i>	<i>Lead fail caused by poor skin-to-electrode contact.</i>  <i>Broken lead wire/cable.</i>  <i>Channel of transmitter doesn't match channel on XScribe.</i>	<i>Correct faulty lead(s) identified in upper right corner of the screen.</i>  <i>Replace patient cable.</i>  <i>Match transmitter channel to same channel setting in the Local Conf/F6 pop up window.</i>
<i>Muscle noise</i>	<i>Electrode placed over muscle or fatty tissue.</i>	<i>Find stable electrode site, re-prep skin, and apply a new electrode.</i>
<i>No response to keyboard commands</i>	<i>Disconnected keyboard cable.</i>  <i>Transposed keyboard/mouse cable.</i>	<i>Turn system OFF. Check keyboard to mouse port connections.</i>
<i>Menu cursor will not move</i>	<i>Disconnected mouse cable.</i>  <i>Transposed keyboard/mouse cable.</i>	<i>Turn system OFF. Check mouse port connections.</i>

## Troubleshooting Chart (Continued)

Screen Message or Issue	Possible Cause	Solution
Treadmill does not respond to the ON command from X-Scribe	<p>Equipment powered up in wrong sequence.</p> <p>Treadmill power switch is off, or treadmill cable not properly attached.</p> <p>Emergency stop switch is engaged.</p> <p>Treadmill settings are incorrect.</p>	<p>Turn treadmill OFF using Softkey menu. Turn power to the treadmill OFF. Wait one minute and turn power back ON. Proceed with test.</p> <p>Secure the treadmill to X-Scribe cable connections. Turn treadmill main power switch ON. (Switch is located at the base of the treadmill hood, left side.)</p> <p>Reset emergency stop switch by turning clockwise one-quarter turn. Reset X-Scribe.</p> <p>Set treadmill to proper setting for corresponding treadmill.</p>
Z200+ writer paper out, light on	Paper jammed.	Open writer cover and remove jammed paper.
Z200+ writer not printing	No paper in tray. Open writer door.	Insert new packet of paper in tray. See if writer door is latched.
Uneven printing of ECGs or reports	Printer head needs cleaning.	Refer to printer head cleaning instructions in Appendix F.
Treadmill belt starts to slip	When loose it can shift.	Tighten adjustment bolts on both sides until slippage stops.
ECG Front-End Error – Can't Proceed	<p>The Front-End device is not correctly connected.</p> <p>The Front-End device drivers are not correctly installed.</p> <p>Incorrect Power Savings settings.</p>	<p>Disconnect the USB cable from the PC. Reconnect the USB cable to the PC. The system emits a confirmation beep.</p> <p>Contact Welch Allyn Service.</p> <p>Restart the PC. Should rebooting the system fix the problem, it is likely that system has incorrect Power Saving settings. Try the following:</p> <ol style="list-style-type: none"> <li>1) Close the X-Scribe application.</li> <li>2) Select "Start", "Settings", then "Control Panel".</li> <li>3) Double click on "Power Management" icon.</li> <li>4) If displayed, set "Stand-by" setting to "Never".</li> <li>5) Click OK and close all open Windows.</li> <li>6) Reboot system.</li> </ol>

## Troubleshooting Chart (Continued)

Screen Message or Issue	Possible Cause	Solution
No Exams are Currently Selected	An attempt to access a final report but no patient is selected from the Search Exam list.	Click on the patient name to select and access the file.
A warning sign appears on the screen next to ST measurements.	The measurement points (J-point, Isoelectric point, or J+ XX msec) have been modified by the user during or after the stress test.	Warning sign indicates that a manual change occurred and that the results are now based on new user determinations.
RA/LA/LL/V1/V2/V3/V4/V5/V6 or C1/C2/C3/C4/C5/C6 FAIL	One or more leads are in fail.	Connect or replace the electrodes to turn off the warning message.
X12+ signal shows artifact even when tested with a simulator.	Signal onscreen shows artifact even when tested with a simulator.	Check that no medical equipment is operating at the same frequency in proximity of the system. Run the RF Scan tool (spectrum analyzer) to locate the optimal channel setting for transmission. Make sure to set the same channel on the X12+ and XScribe.
No signal onscreen	With the patient connected (or with a simulator) no waveforms are displayed, but only the squared waveform/lead fail indicator appears (wireless option). <b>NOTE:</b> if neither the signal nor the squared waveform is present, ESC or Abort and start a new exam from the main menu.	Check that XScribe and the digital transmitter work on the same channel. Refer to the transmitter user manual to check and change channel. Refer to Settings in this manual to set the receiving channel for XScribe.

**Troubleshooting Chart** (Continued)

<b>Screen Message or Issue</b>	<b>Possible Cause</b>	<b>Solution</b>
<i>No signal from X12+ Transmitter</i>	<p><i>X12+ is not selected as Front End.</i></p> <p><i>M12RF-USB cable is unplugged.</i></p> <p><i>Drivers for M12RF-USB not loaded.</i></p>	<p><i>Select X12+ as front end in the Observation screen.</i></p> <p><i>Place USB plug into any rear USB slot.</i></p> <p><i>Load drivers for M12-USB from XScribe software CD.</i></p>
<i>No signal from the M12A patient cable connection</i>	<p><i>M12A is not selected as Front End.</i></p> <p><i>USB cable plugged into wrong USB slot.</i></p> <p><i>Drivers for M12-USB patient module not loaded.</i></p>	<p><i>Select M12 as front end in the Observation screen.</i></p> <p><i>Assure M12-USB Green light is on, if not plug USB cable into the USB adapter on the upper left-hand side.</i></p> <p><i>Load drivers for M12-USB from XScribe software CD.</i></p>
<i>No signal from the AM12 patient cable connection</i>	<p><i>AM12 not selected as Front End.</i></p> <p><i>Drivers for AM12 patient cable not loaded.</i></p>	<p><i>Select AM12 as front end in the Observation screen.</i></p> <p><i>Load drivers for AM12 from XScribe software CD.</i></p>
<i>No Network or LAN communication</i>	<i>RJ45 plug connected to the wrong RJ45 slot.</i>	<i>Disconnect the RJ45 plug from the back of the PC and connect it to the other RJ45 slot.</i>

# CONFORMANCE TESTING

---

## Conformance Testing

Conformance testing is to be performed by Authorized Welch Allyn Service Representatives to verify the device is functioning correctly after repair operations have been performed. Testing results should be documented on the test data record at the end of this section of the manual.

## Acquisition module preparation

Connect a patient simulator to an X12+ or AM12 patient interface. If using an AM12 interface, connect the AM12 to a USB port on the PC.

## System Checks

### Archive Management

With customer's assistance, create additional Archive folders on the root directory or on the network (if option installed). Refer to the XScribe User Manual (9515-151-50-ENG) for complete instructions. Archive all the patient exams from the root Archive to the newly created Archive locations.

### Hard Drive Space

Check the capacity of the system hard drive to ensure there is sufficient space for system operation. If the system drive is nearing capacity (approaching 90%), this issue should be discussed with the facility to create additional space for proper operation. If the drive was near capacity and unnecessary files were removed, a defragmentation may be performed to ensure optimal performance of the drive.

*Note: The defragmentation process may take several hours and is only required in extreme cases.*

### Z200+ Writer Test

Using the Z200Plus Monitor software, print off a test page. The Z200PlusMonitor software can be loaded onto the X-Scribe system or ran from USB stick. Double click Z200PlusMonitor icon to launch the application. Press Connect and then press Print Test Page. Verify on the print out page that there are no missing pixels or light printing. Now press Disconnect and close the application.

## Functional Testing

- Click on the **Start Stress Test** icon and select the **Search Patient** button. Click **New Patient** and enter test patient demographics.
- Click **Confirm** and verify the test starts. ECG data should begin to be displayed. Verify **Bruce** is the selected protocol from the top left hand drop down menu.
- Click the **Begin** button and allow about a minute of data to be collected. Then press the **Start Exe** button and verify treadmill turns on and begins to move.
- Allow the system to run through the full Bruce protocol. Verify treadmill is rising and that the speed increases throughout test. Verify printouts are coming from Z200+ writer or Laser Printer (if the option is installed).
- Once the test enters the Recovery phase, verify the treadmill slows down and returns to 0% grade. Press the **ECG F11** button and verify a printout comes from the Z200+ writer or Laser Printer (if the option is installed).
- Press the **END F1** button and verify the test goes in to the Report Manager screen. Real Time ECG data should still be displayed at the bottom of screen. Press the **ECG** button and verify a printout comes from the Z200+ writer or Laser Printer (if the option is installed).
- Press the **EXIT** button and verify system exits the Report Manager screen.
- Verify the test results were stored properly in the appropriate location, and that any configured data export options were performed.

## Safety Testing

The following safety tests should be performed in accordance with IEC 60601 or IEC 62353 standards and all local regulatory requirements:

- Earth Leakage (performed on medical isolation transformer)
- Enclosure Leakage (performed on medical isolation transformer)

*The following safety tests are required only for systems utilizing a wired patient interface.*

- Patient Leakage
- Patient Leakage Type-F
- Patient Auxiliary Current



## XScribe 5 System - Test Data Record

XScribe Serial #: \_\_\_\_\_

Treadmill Serial #: \_\_\_\_\_

- System Checks
  - Archive management
  - Sufficient Hard drive space
  - Print writer test page and inspect for proper operation/darkness
- Functional Testing
  - Perform lead check on system transmitter(s) and patient cable(s)
  - Perform a full stress test with a patient simulator
  - Verify treadmill turns on as per protocol settings
  - Verify writer prints as per protocol settings
  - Verify test results were properly stored
  - Verify data export functionality (if option installed)
- Safety Testing
  - Earth Leakage
  - Transformer Enclosure Leakage
  - (The following tests are performed for wired patient inputs only)*
  - Patient Leakage
  - Patient Leakage Type-F
  - Patient Auxiliary Current

- 
- Treadmill Inspection / Maintenance
    - Running Belt Cleaning & Inspection
    - Running Belt Tension Check / Adjustment
    - Drive Belt Tension Check / Adjustment
    - Elevation Screw Lubrication
    - Control Cable Fastened/Routed Appropriately
  - Treadmill Functional Testing
    - Test Plug Operation
    - XScribe Control Test
    - Emergency Stop Button Check

Performed By: \_\_\_\_\_ Date: \_\_\_\_\_ / \_\_\_\_\_ / \_\_\_\_\_

## **COMMUNICATION OPTIONS**

---

### **File Exchange**

XScribe supports the ability to import orders from XML files and export PDF and XML results to an external system depending on the activated system features. Import/Export directories for the selected group are defined in the File Exchange window in System Configuration.

XScribe also supports DICOM communications. DICOM settings are entered through the System Configuration icon, then clicking on the DICOM Settings button.

Refer to the Scribe Data Exchange Administrator Manual (P/N: 9515-185-51-ENG) for external system integration details.

## System Utilities

The following utilities are located at the path below to assist with system configuration and service functions as defined.

### C:\Program Files (x86)\Welch Allyn Inc\ModalityMgr

Configurator.exe	(language, networking, login)
FetchAllConfig.exe	(gathers all system configuration data)
ActivationTool.exe	(software license information)
CFDWizard.exe	(display and report configurator)

### Configurator.exe

The Modality Manager Configuration Utility is stored as a unique EXE file (Configurator.exe) that can be accessed after the installation process is completed if any changes are needed to the Modality Configuration settings.

Modality Manager Configuration Utility

Language  
English System user interface language

Server Address  
localhost Computer name or IP address of Modality Manager server

LOG port  
7500 OK Modality Manager centralized event log service port  
Keep default unless not available

API port  
7502 OK Working port of the Modality Manager service  
Keep default unless not available

Logon Mode  
Local Choose the logon authentication method  
 Single Sign On  
 - Local: Modality Manager will maintain its own list of user/password pairs  
 - Active Directory: Modality Manager will get the list of users from the Windows domain

Save Exit

Refer to the following information regarding the configuration settings:

**Language:** This setting is always available to select the desired language.

**Server Address:** The Server Address will read “localhost” if the local PC is hosting the Modality Manager database. If Modality Manager is not local, this box should contain the IP Address or Computer Name of the PC or server hosting Modality Manager.

**Log Port:** This setting is always available to select the port to be used for the event log service.

**API Port:** This setting is always available to select the port to be used for Modality Manager service.

**Logon Mode:** This setting can be set to either Local or Active Directory depending on the user preference. If Local is selected, the Modality Manager service will maintain its own local listing of user/password pairs for logging onto the system.

If Active Directory is selected, the Modality Manager service will access the list of users from the Windows domain.

# SYSTEM UTILITIES

## FetchAllConfig.exe

Copies all of the system configuration settings into the file structure displayed below to allow this information to be sent to a Welch Allyn Service Center. The path can be entered by the user upon executing the utility.

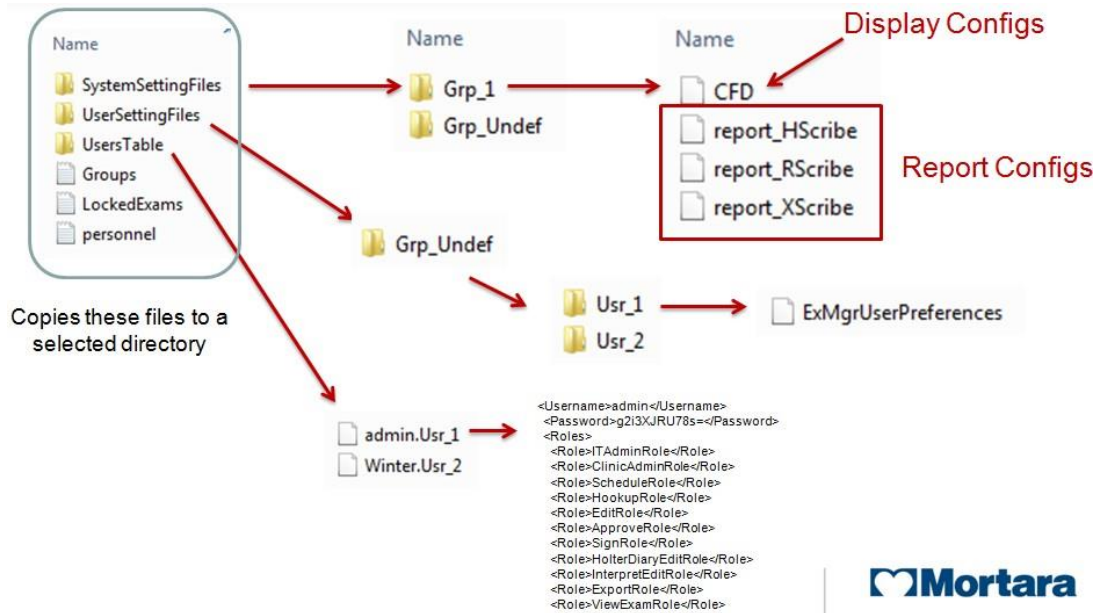

## ActivationTool.exe

This utility will display the current software license status, serial number information, and all enabled options.

The serial number information is necessary when contacting a Welch Allyn Service Center for technical assistance.

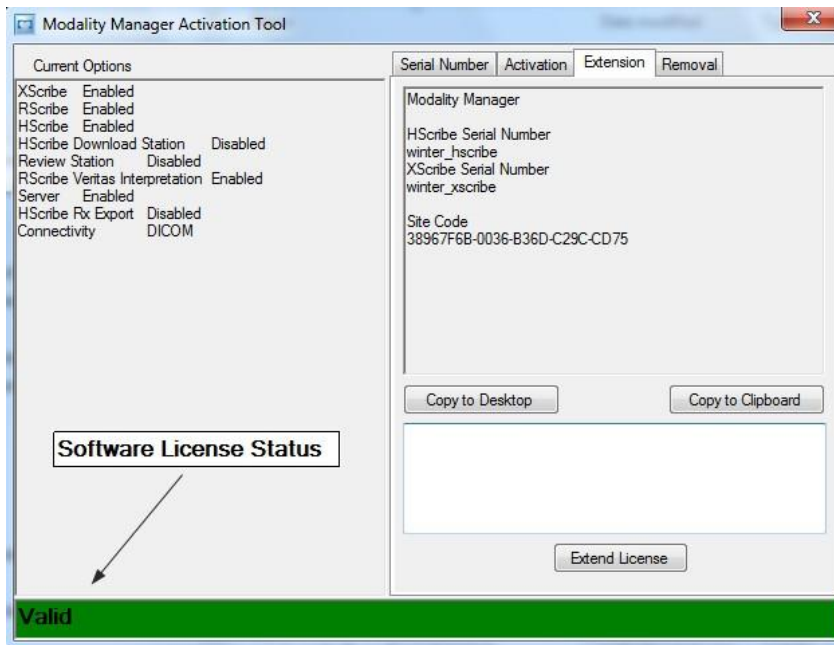

The Activation Utility is also used to perform a software Removal, which **MUST** be performed prior to uninstalling the Welch Allyn software. The software Removal process will generate a Removal Code, which will need to be sent to Welch Allyn to provide notification that the software license has been deactivated.

Once the software Removal has been reported to Welch Allyn, the software may be loaded on another computer and activated through the normal activation process.

## CFDWizard.exe

The CFD (Custom Format and Display) Wizard can be used to change the following items:

- Logo
- Facility Name
- Facility Address
- Phone Number
- Hide Items

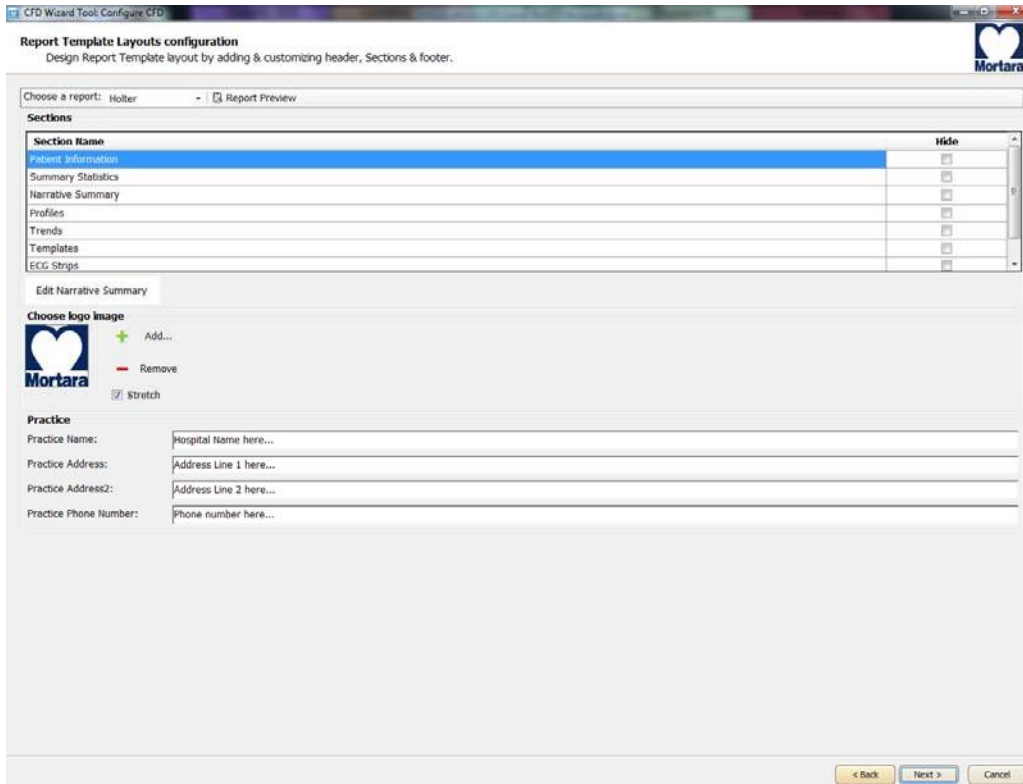

Customization of the Scribe 5 display appearance and reports are also available. Please contact your regional Welch Allyn Service Center for assistance with this level of customization.

# SYSTEM BACKUP AND RESTORATION

---

## System Backup

The Scribe 5 system installs a batch file that will back up all of the necessary data required to restore the system to operation in the case of a system failure. This file can be modified to direct the system to store the backup data to an alternate non-local location or designated storage system (recommended).

User must be logged into the operating system as a user with administrative permissions.

The backup file is located at the following path:

**C:\Program Files\Welch Allyn Inc\Welch Allyn PgSql\scripts>Backup.bat**

- Double click on Backup.bat
- A Command Prompt window will open and the backup process will begin, once the Command Prompt window closes the backup is complete.

Executing the system backup copies the following information into a file called **CorScribeFullBackup.7z** located on the TEMP folder of the logged in user.

- SQL Database information
- Full Disclosure Data
- User Configuration Settings

*This may be a hidden file based on the current system settings.*

### **Backup Notes:**



### **Caution**

Configuration settings made via the Modality Manager Configuration tool and the SW Activation utility are not stored in the DB, and are not included in the system backup.

The following items will need to be properly configured with the use of the tools/utilities after the restoration process:

- Language setting (in the server)
- The ports where the MM server and Log server can be found
- The authentication method (local vs. AD vs. AD+SSO)
- Serial number
- License/features

In case of restoring from a total failure (unrecoverable system, reinstall of the OS etc...), the first group of settings should be correctly reentered during the install of the application. The user will have to go through the activation process again, hence an Activation Code will have to be regenerated (the old Activation Code cannot be used) and – during the process – S/N should be restored.

Everything else (users, DICOM settings, Modality settings etc...) is in the DB, hence it is backed up.



- *It is recommended that the backup be performed while the system applications are not in use (not receiving any data).*
- *The Backup.bat routine can be added as a scheduled process through the Task Scheduler*
- *If a local backup (factory default) is used It is recommended that after a backup has been performed that the file created from the backup be removed from the system and placed in a safe (non-local) location.*
- *The process is the same for a stand-alone system and a distributed system; when performing the backup on a distributed system the process must be performed on the PC or server that is running Modality Manager.*
- *The backup process can be customized by modifying the DefaultBackupSettings.bat file and renaming the modified file to CustomBackupSettings.bat*
  - *Information regarding modifications to the backup file is located within the Backup.bat file itself.*
  - *Please contact Welch Allyn Technical Support Group if you require assistance with modifying the backup file.*
  - *Welch Allyn technical support can assist with the modification of the backup file, however Welch Allyn will not retain a copy of the file.*
- *On a distributed system the backup zip file may be parked in a sub folder:*

*C:\Users\<User>\AppData\Local\Temp\1*

*This may be a hidden file based on the current system settings.*

## System Restoration

(restores to point of last performed backup)



### Caution

- *It is recommended that the restore be performed while the system applications are not in use (not receiving any data).*
- *The process is the same for a stand-alone system and a distributed system; when performing a Restore operation on a distributed system the process must be performed on the PC or server that is running Modality Manager.*

The following process should be followed to restore a Scribe 5 system.

1. Prepare/Repair PC
2. Load OS (if applicable)
3. Install Product Software
4. Place file **CorScribeFullBackup.7z** in the correct restore location
5. Run Restore batch file

User must be logged into the operating system as a user with administrative permissions.

- Place the backup file into the appropriate folder:

`C:\Users\<<Administrator Name>\AppData\Local\Temp`

On a distributed system the file may be located in a sub folder:

`C:\Users\<<user>\AppData\Local\Temp\1`

*This may be a hidden file based on the current system settings.*

- Navigate to the following path to locate the Restore.bat file

**`C:\Program Files\Welch Allyn Inc\Mortara PgSql\scripts>Restore.bat`**

- Double click on the Restore.bat file
- A Command Prompt window will open and the Restore process will begin
- The Restore program will ask whether or not CreateDB.BAT will need to be run before the restore is executed. If the system database does not need to be recreated, answer NO to this question. If the system database has been damaged, or is being recreated, answer YES to this question.

- Once the Command Prompt window closes the backup utility has completed restoring the following content:
  - *SQL Database information*
  - *Full Disclosure Data*
  - *User Configuration Settings*
- Verify that the appropriate data has been restored (system settings or system settings and exam data) and that the exams can be accessed.